

12+

**40**  
BUILD

INSTRUCTION  
MANUAL

**238** pcs



IMPERIAL AT-AT™  
3D Cardstock Model Kit

**STAR  
WARS**™

Apply glue to areas where you feel the tabs may become loose. Full drying time is approximately 45 minutes. For faster assembly time, please use fast-drying glue as an alternative.

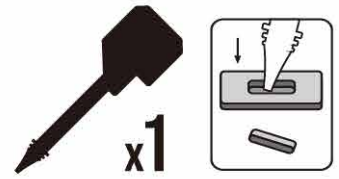

**Contents: 16 3D Cardstock Sheets,  
1 Punch Tool, Glue**

**CAUTION:** Do not drink glue. May be harmful if swallowed. Keep out of reach of pets and small children. May produce an allergic reaction in sensitive individuals. Keep it away from face, eyes and hair. Rinse eyes thoroughly in case of contact. Wash hands thoroughly with mild soap and water. Do not store or use product near heat, sparks or flame. Protect from exposure to direct sunlight. Replace cap after use. Spills can be wiped up with a damp cloth. Applicator can be washed in warm water.

# IMPERIAL AT-AT™

**1**

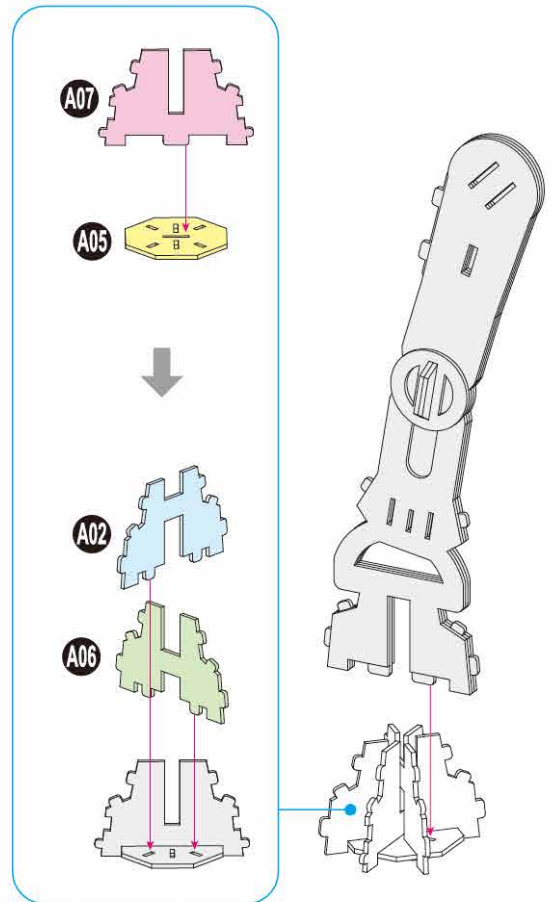
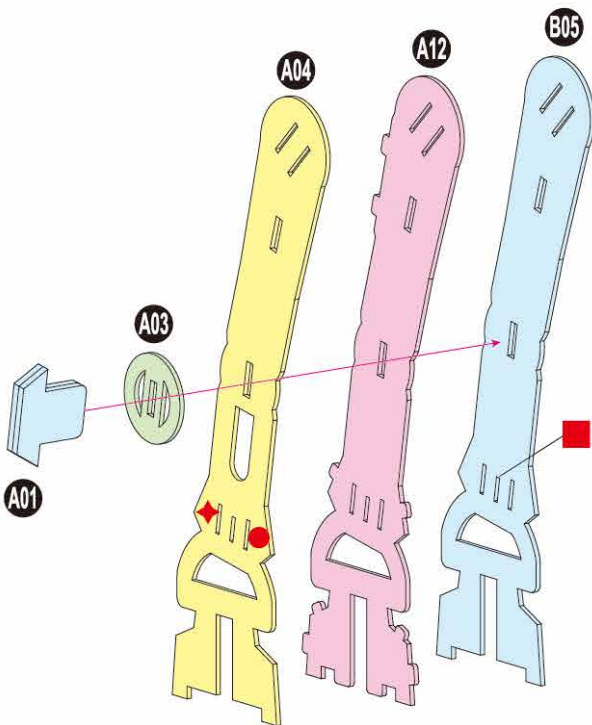

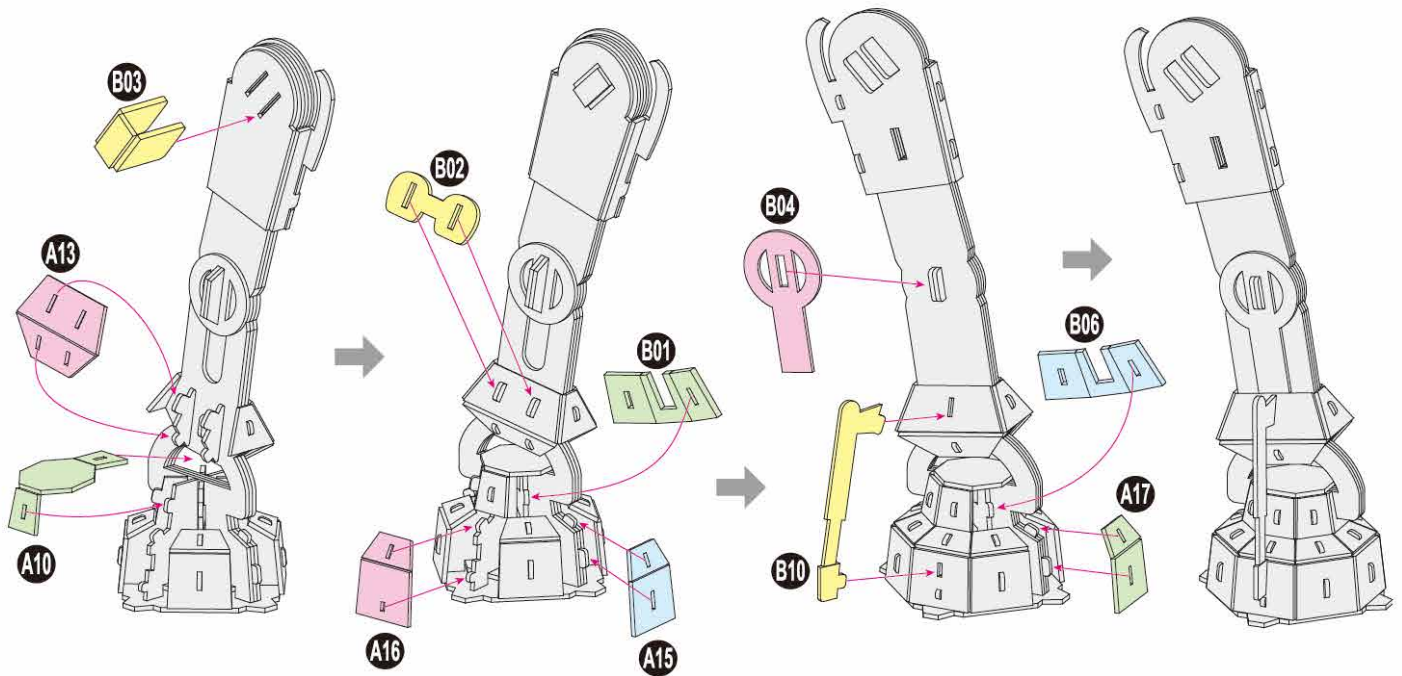
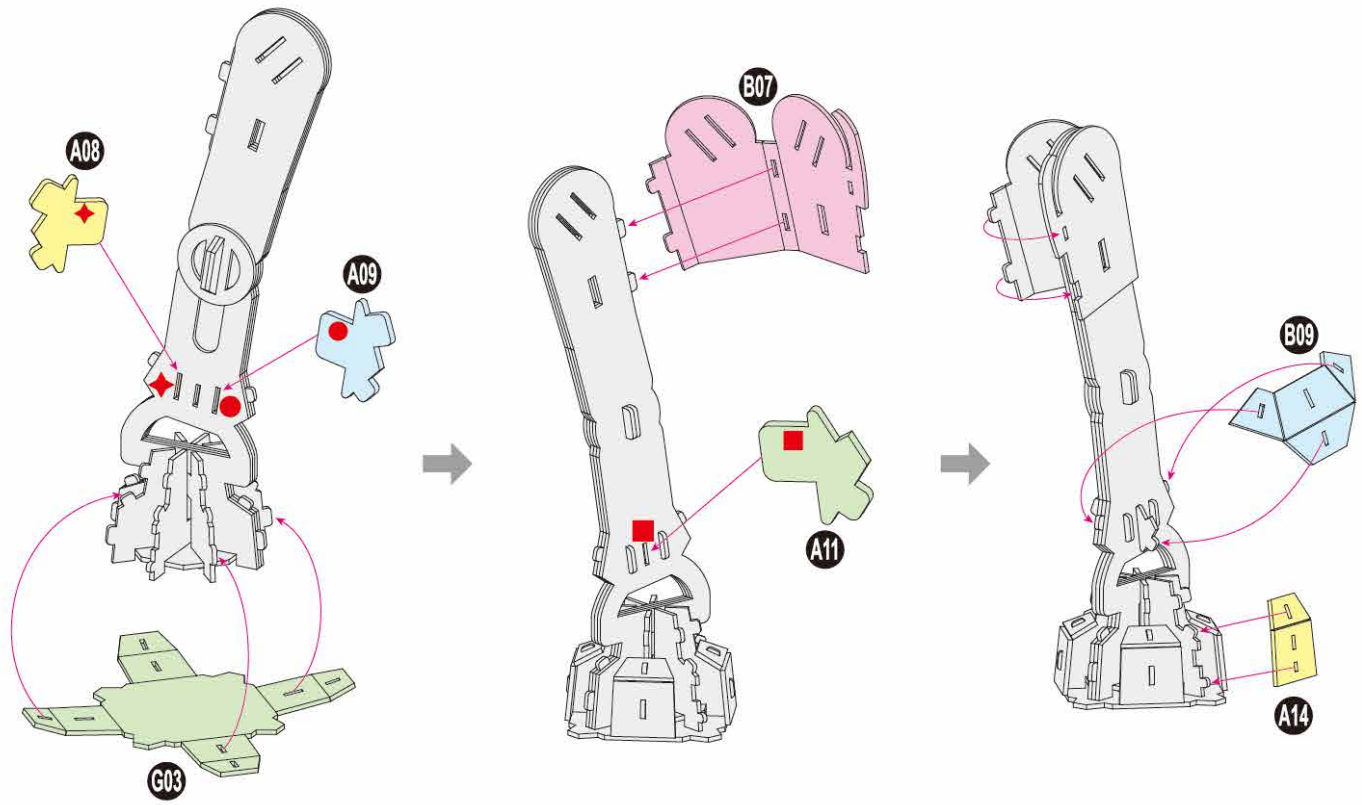

There are no more pieces left on Sheet A.



2

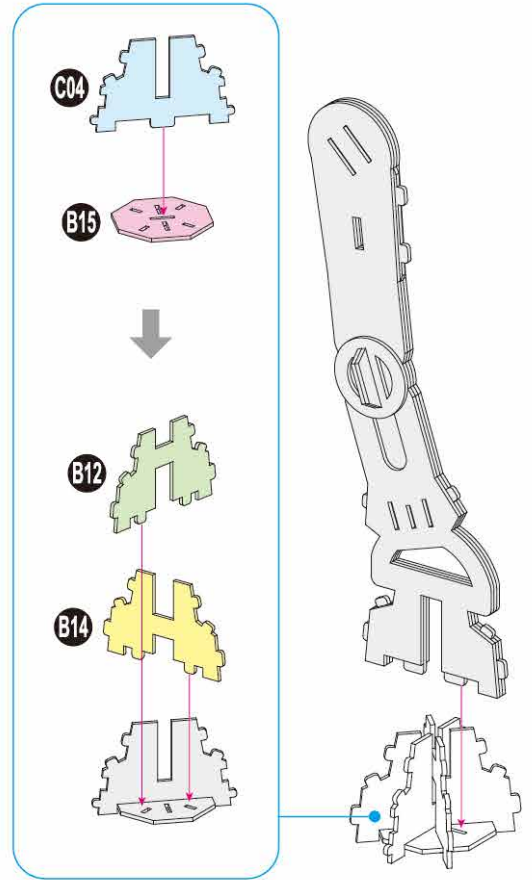
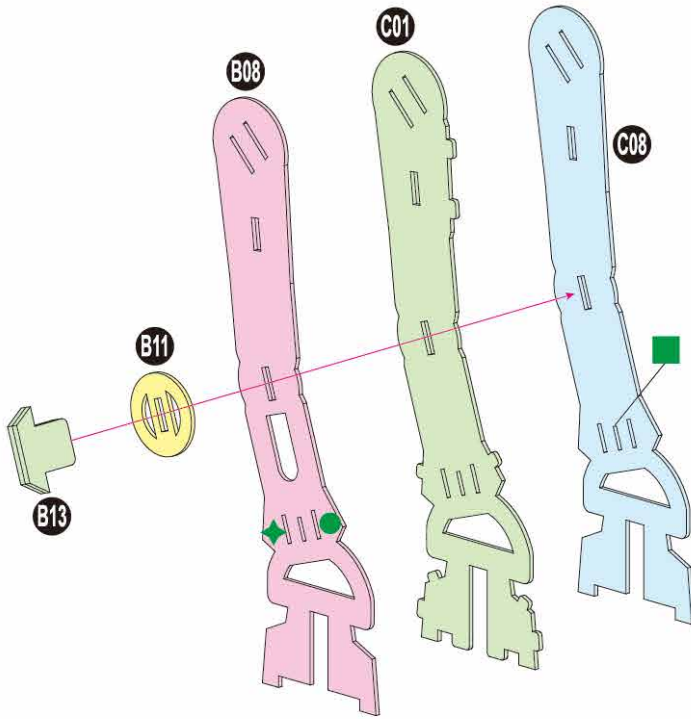

There are no more pieces left on Sheet B.

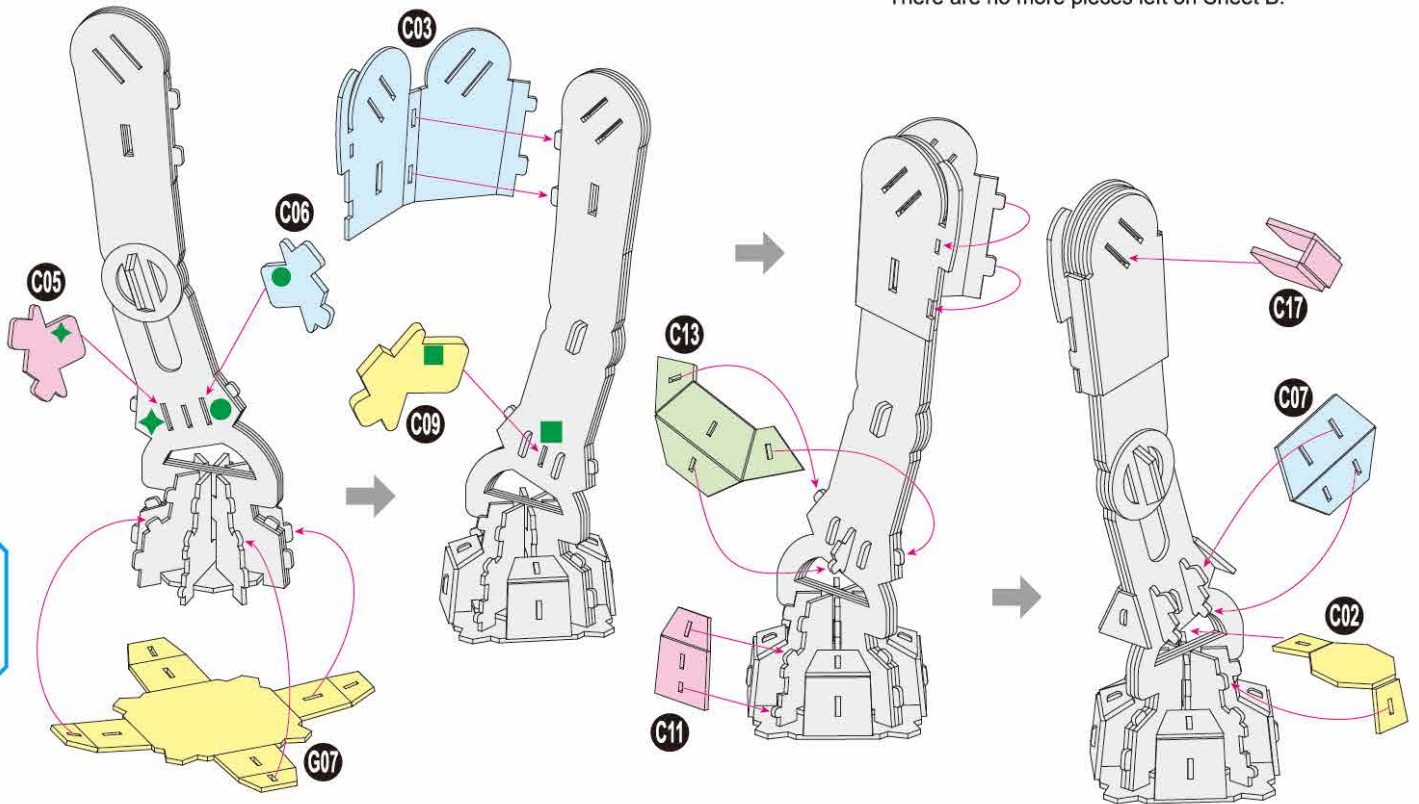

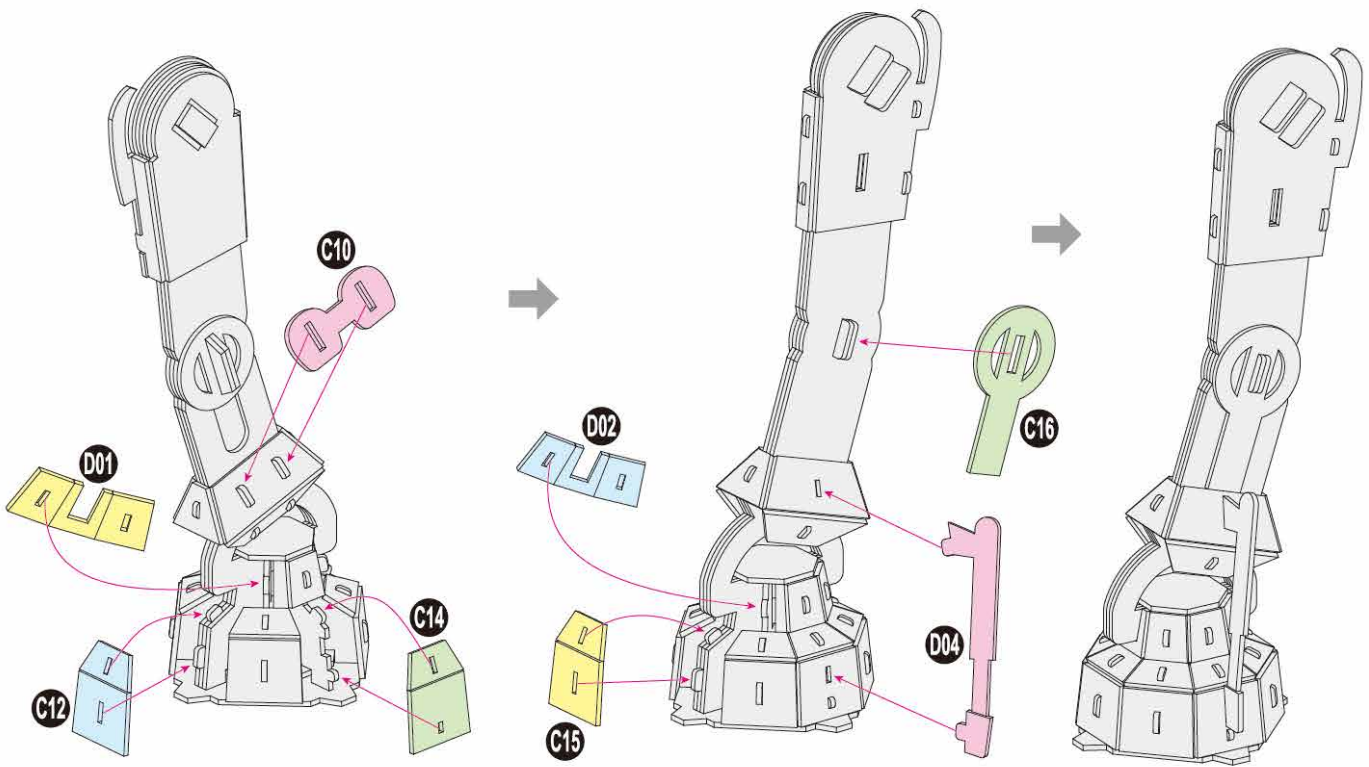

There are no more pieces left on Sheet C.

3

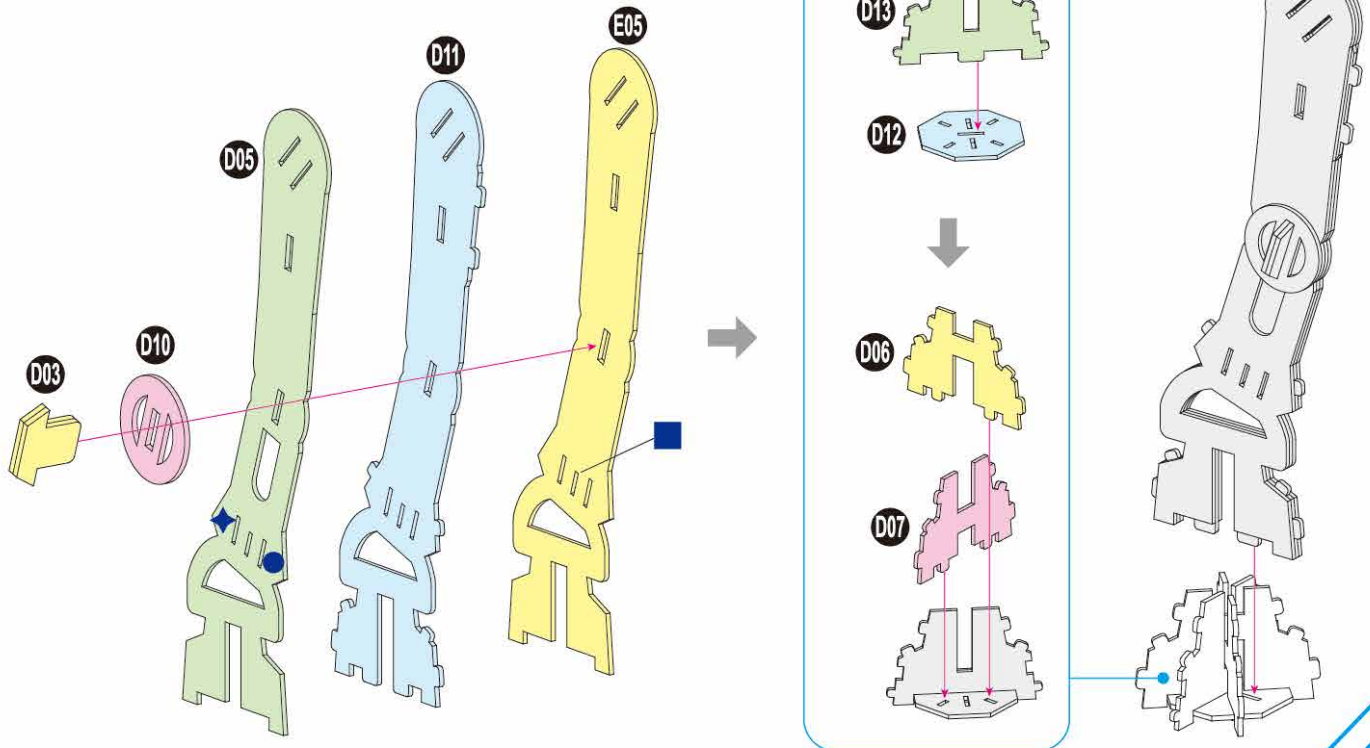

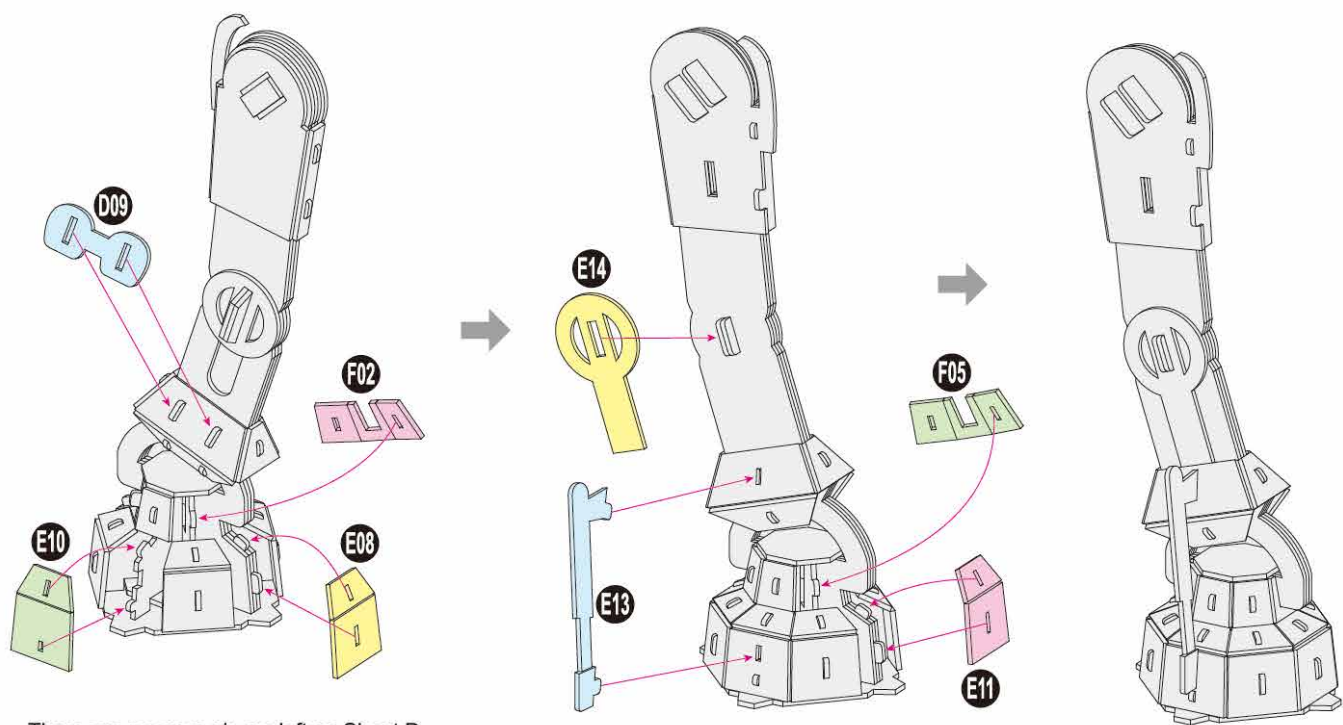
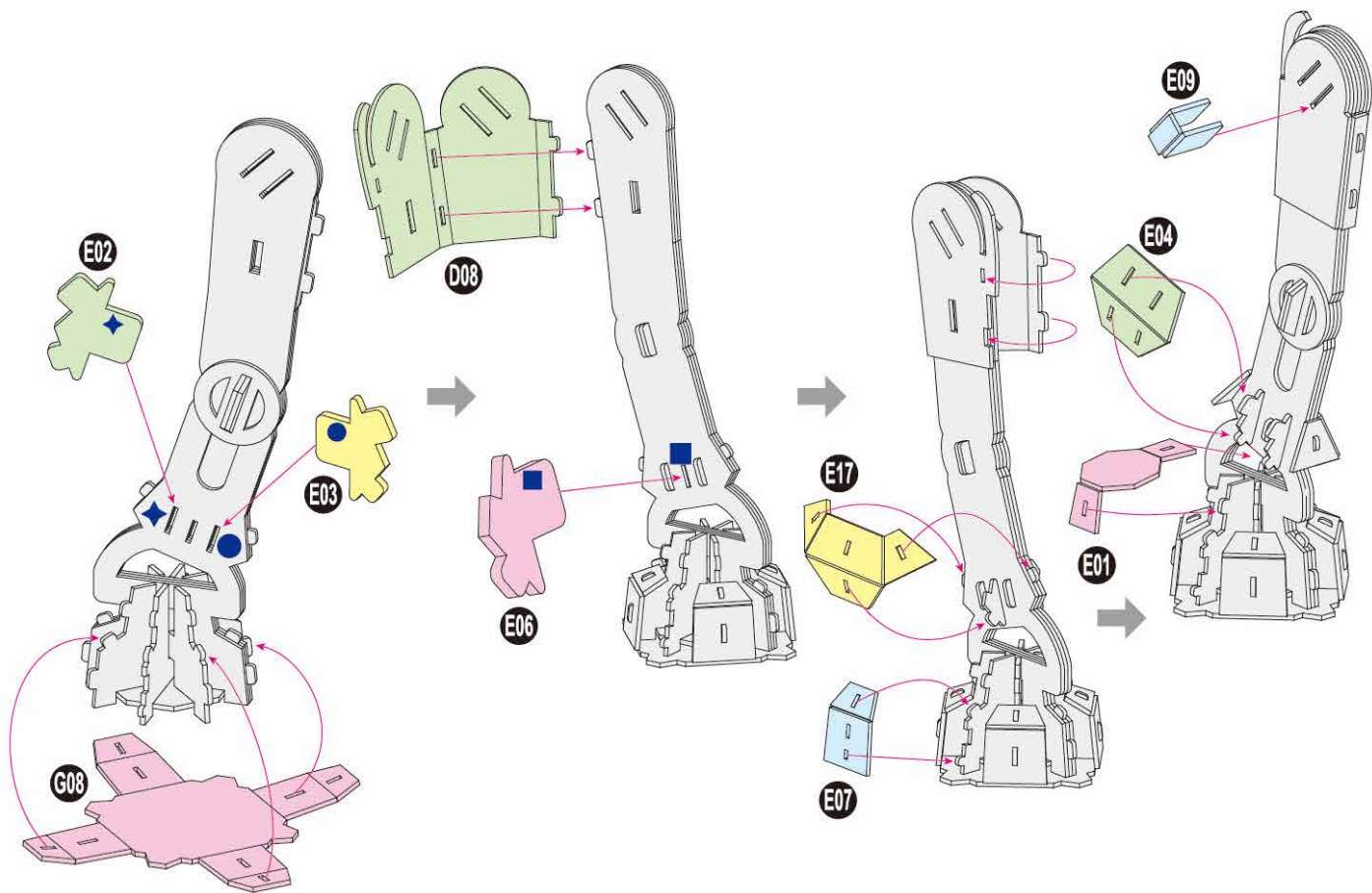

There are no more pieces left on Sheet D.



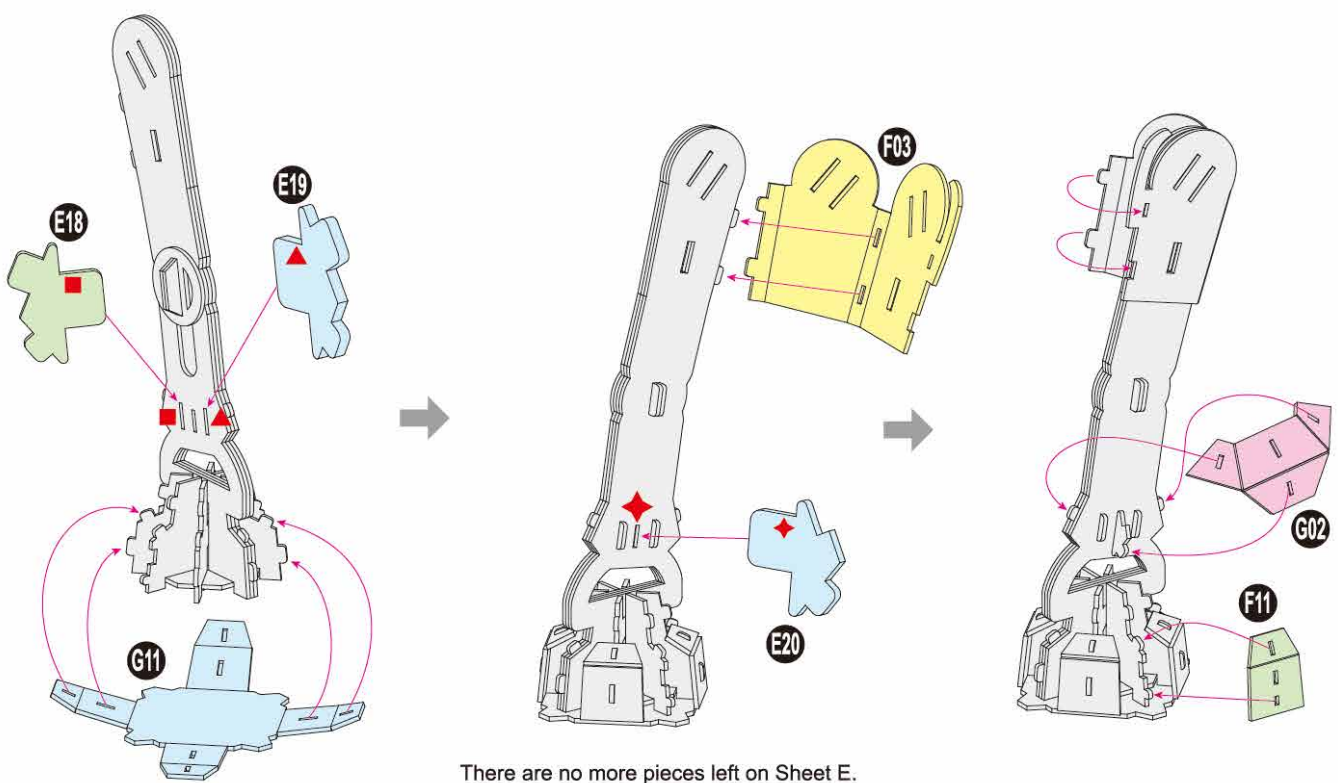
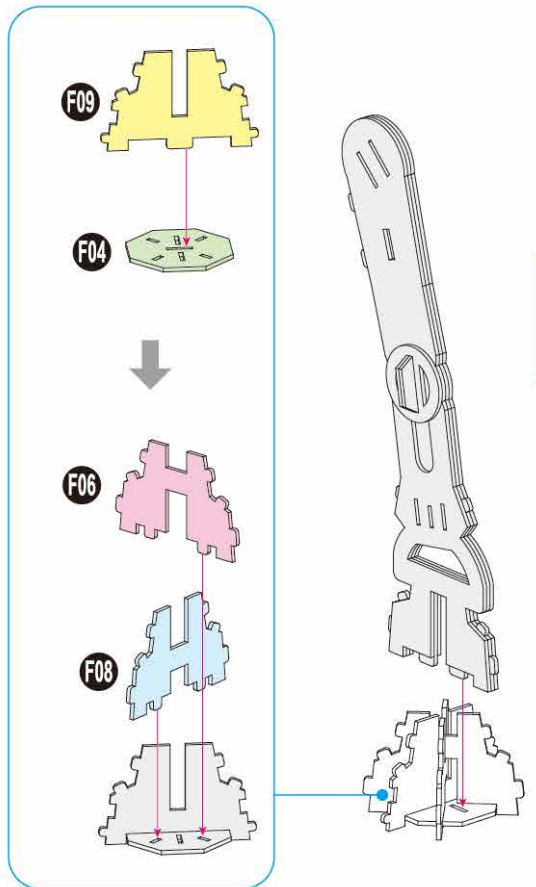
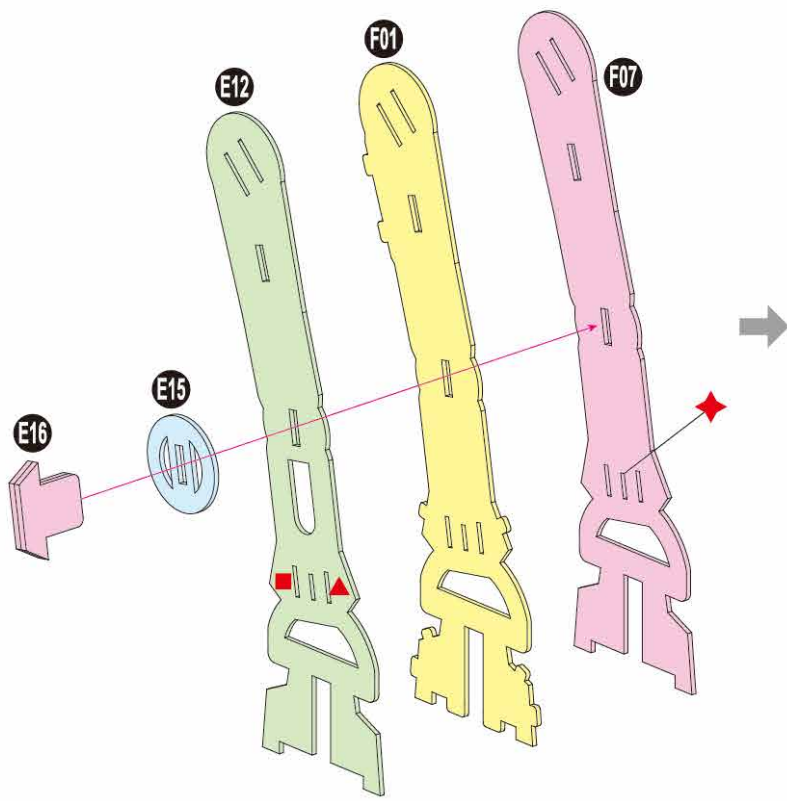

There are no more pieces left on Sheet E.

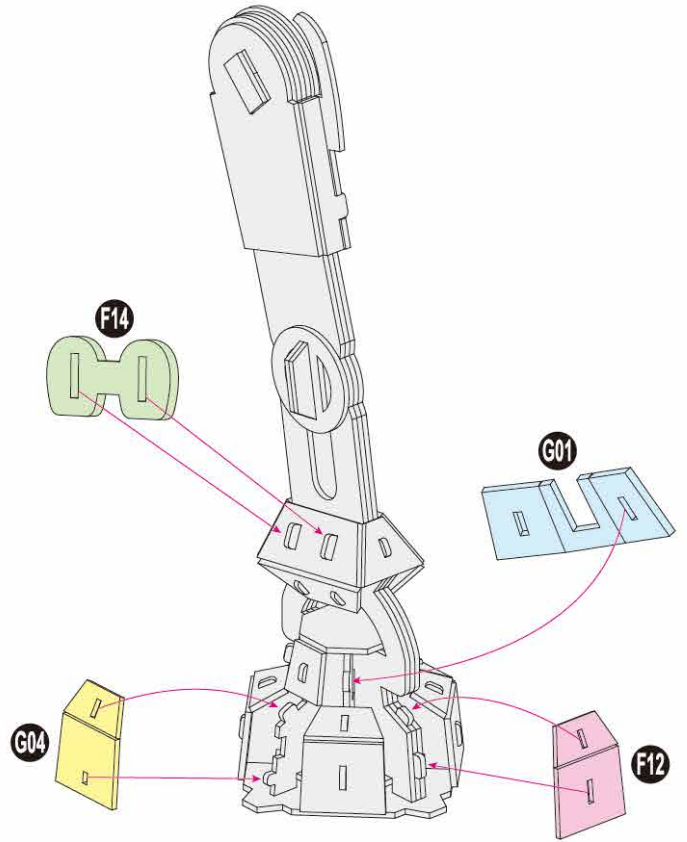
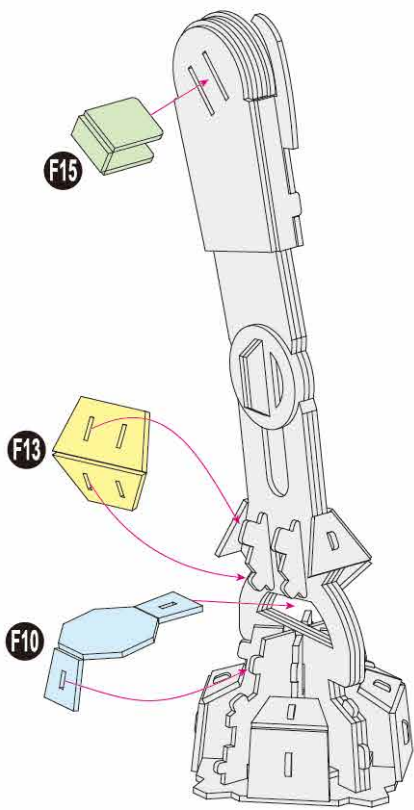

There are no more pieces left on Sheet F.

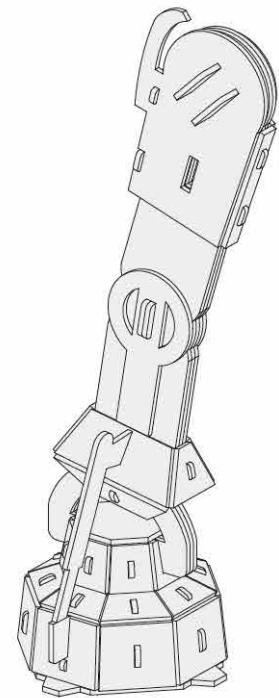
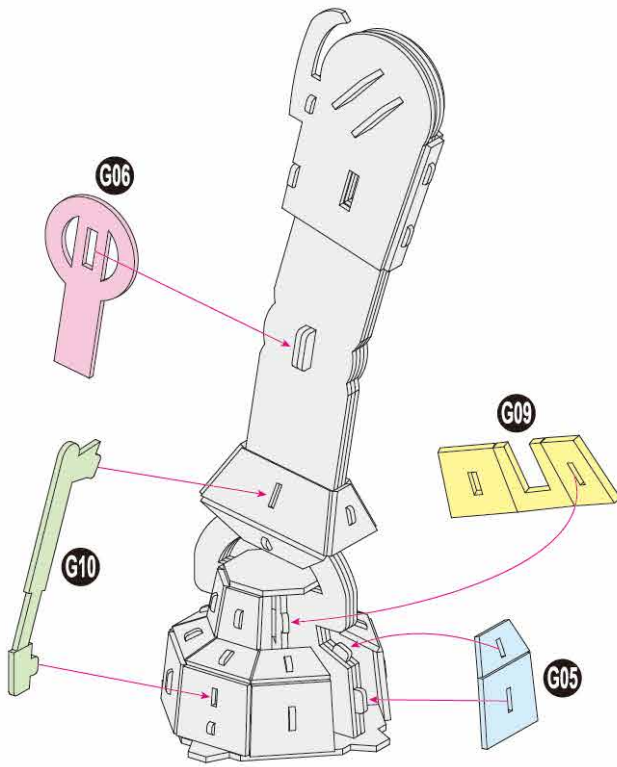



5

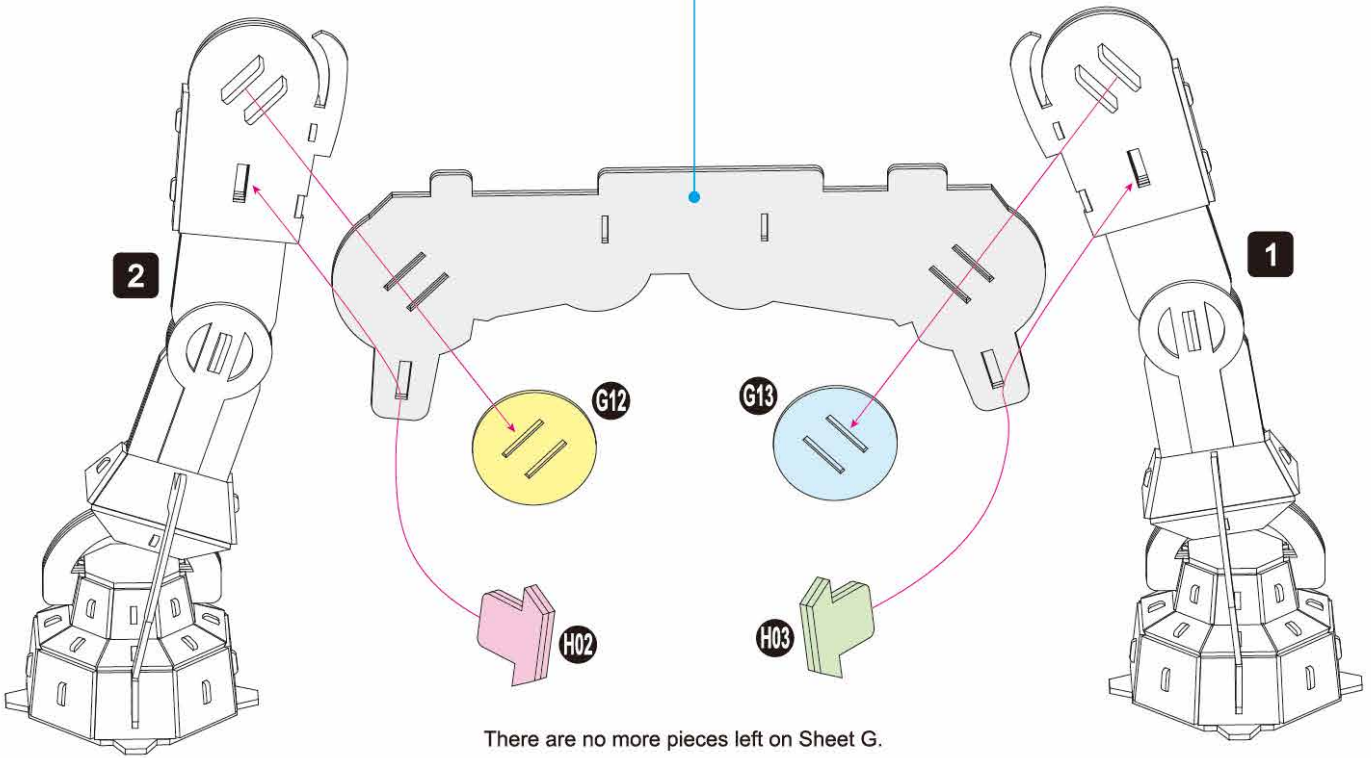
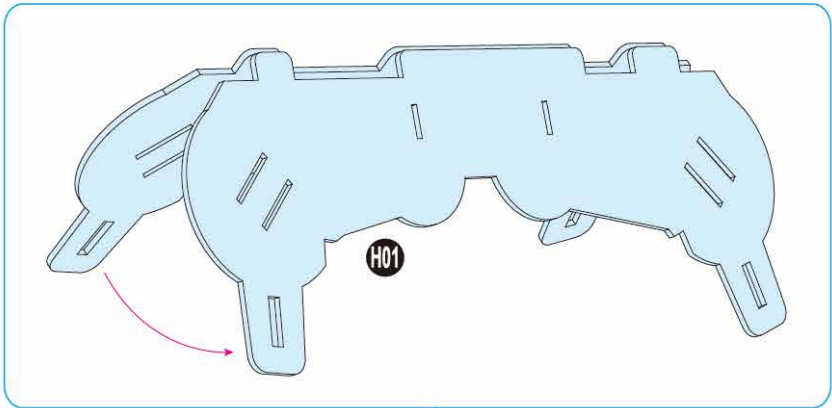

There are no more pieces left on Sheet G.

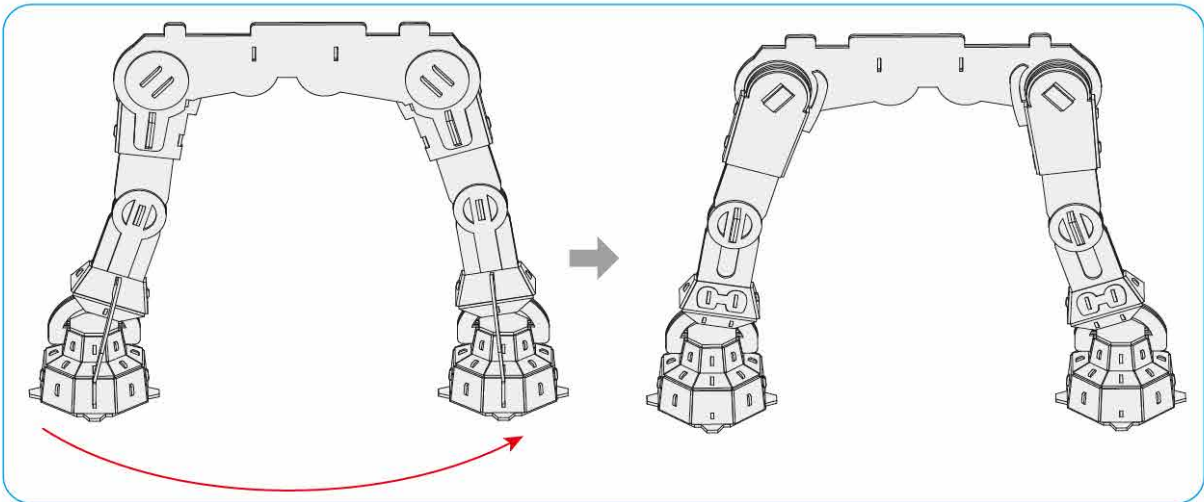

6

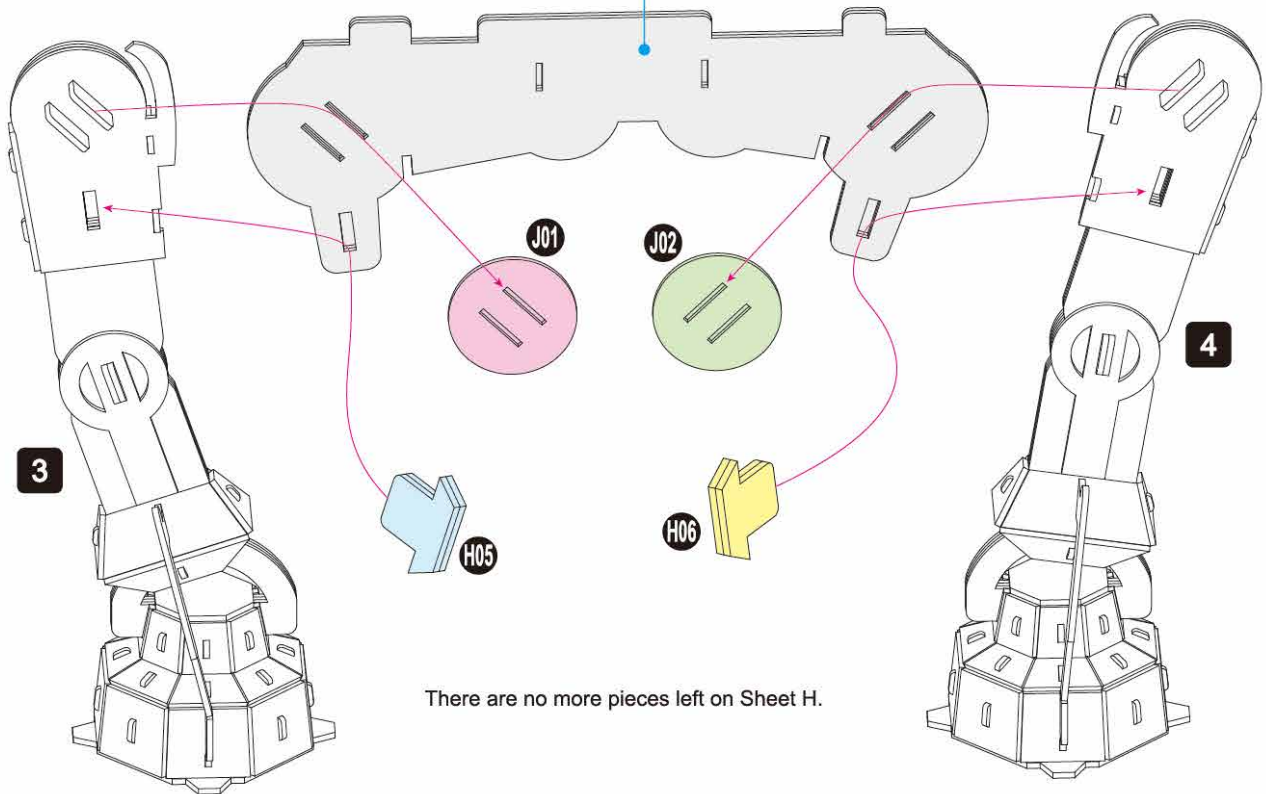
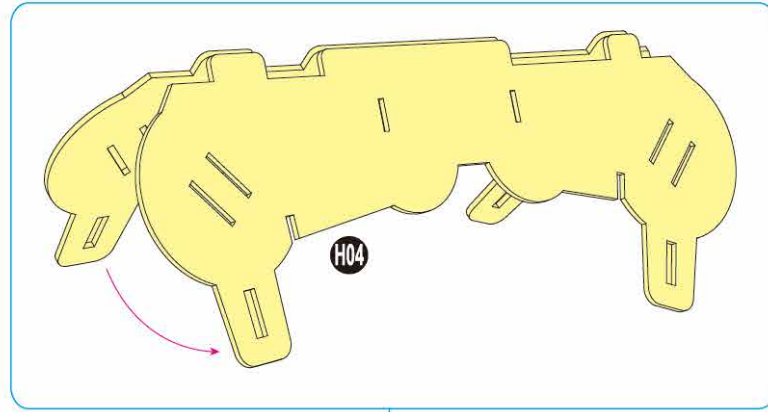

There are no more pieces left on Sheet H.

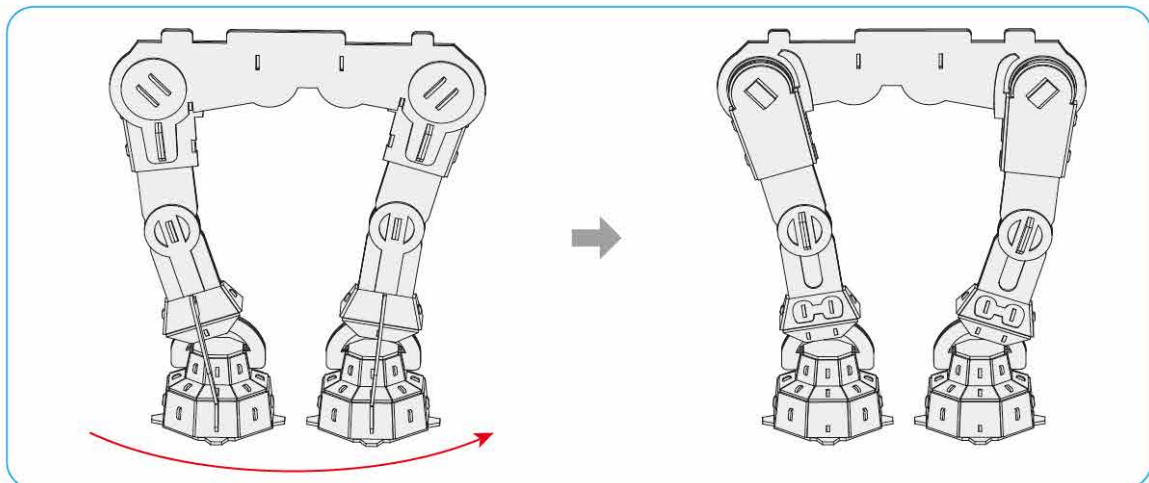

7

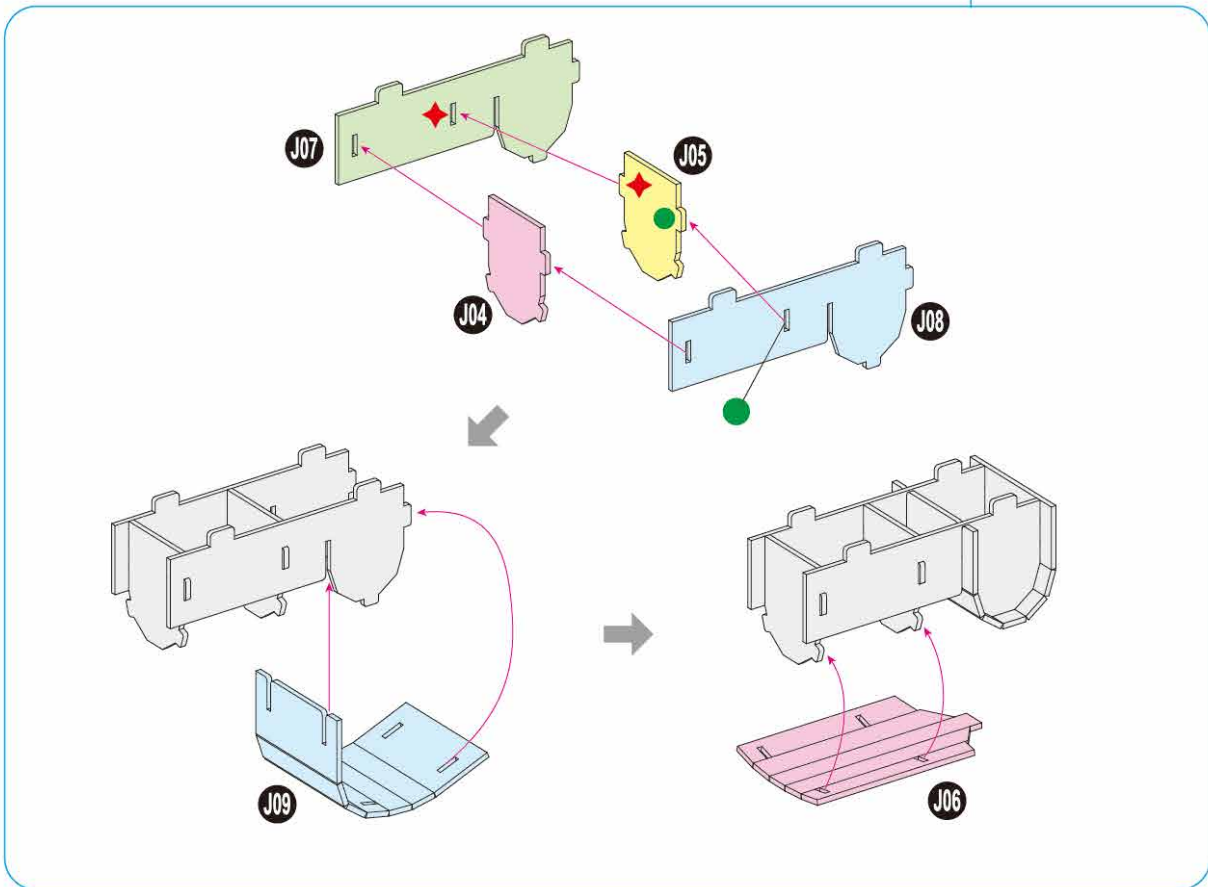
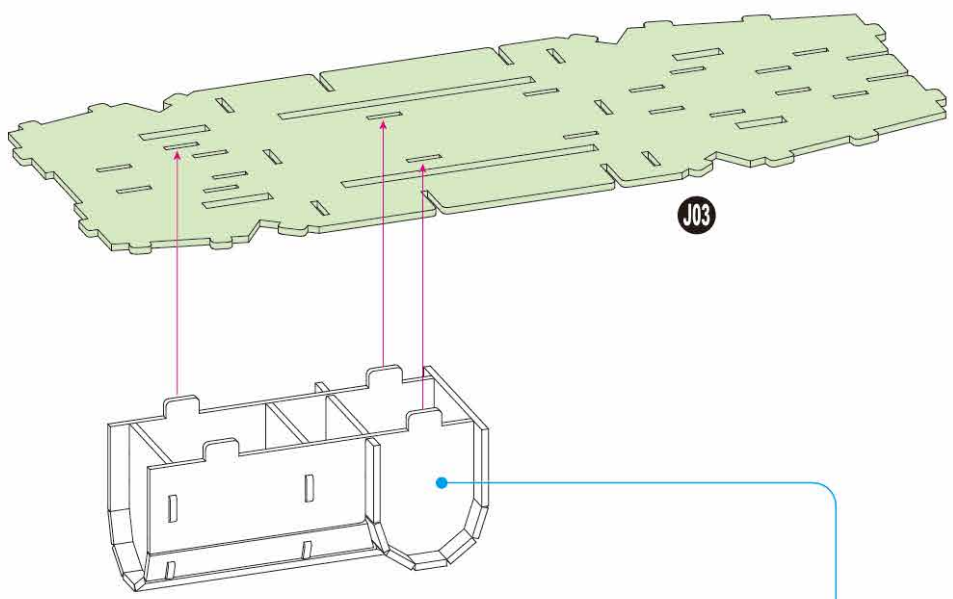



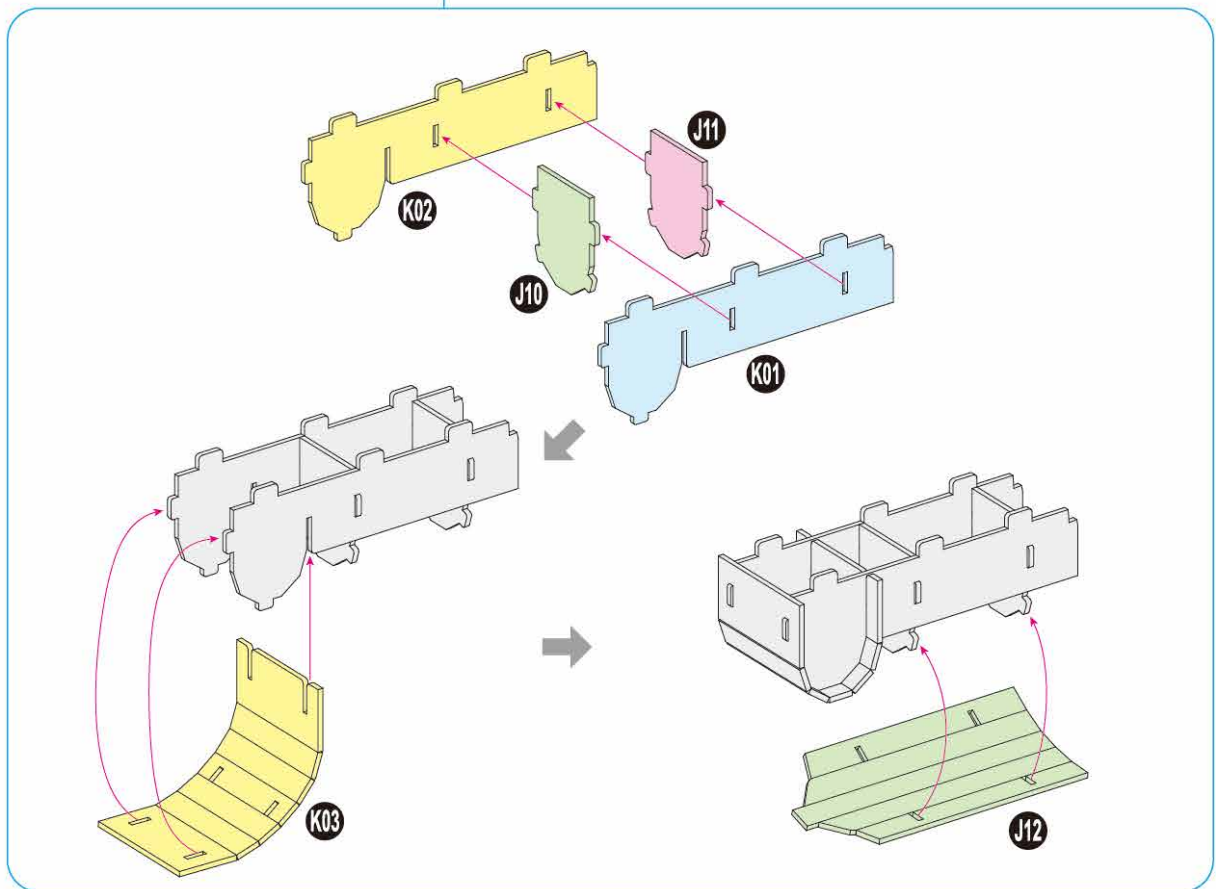
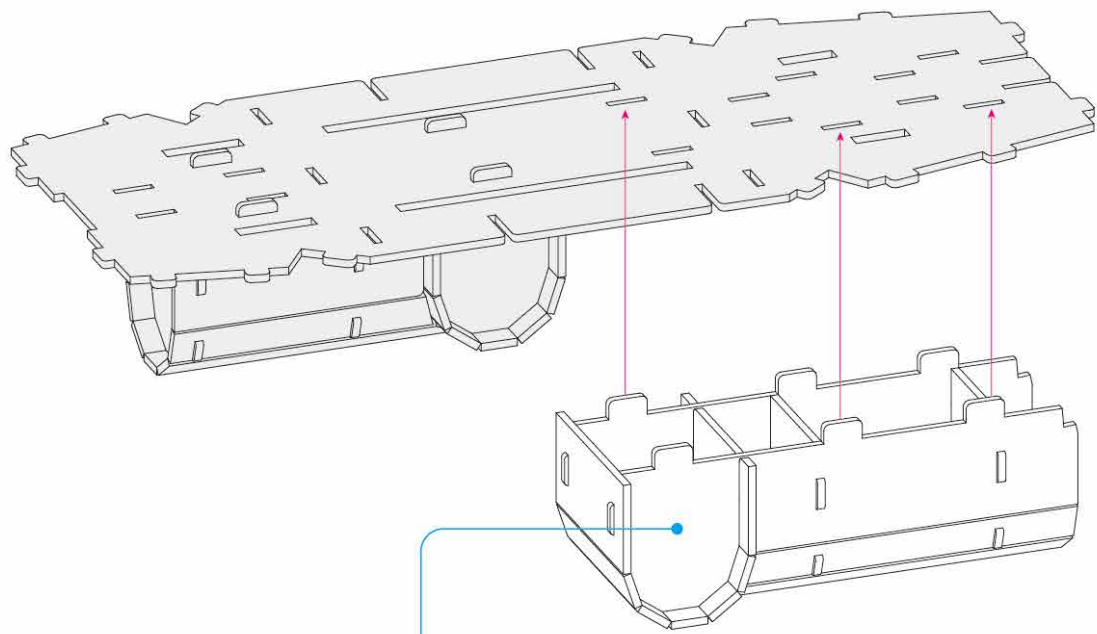

There are no more pieces left on Sheet J.

8

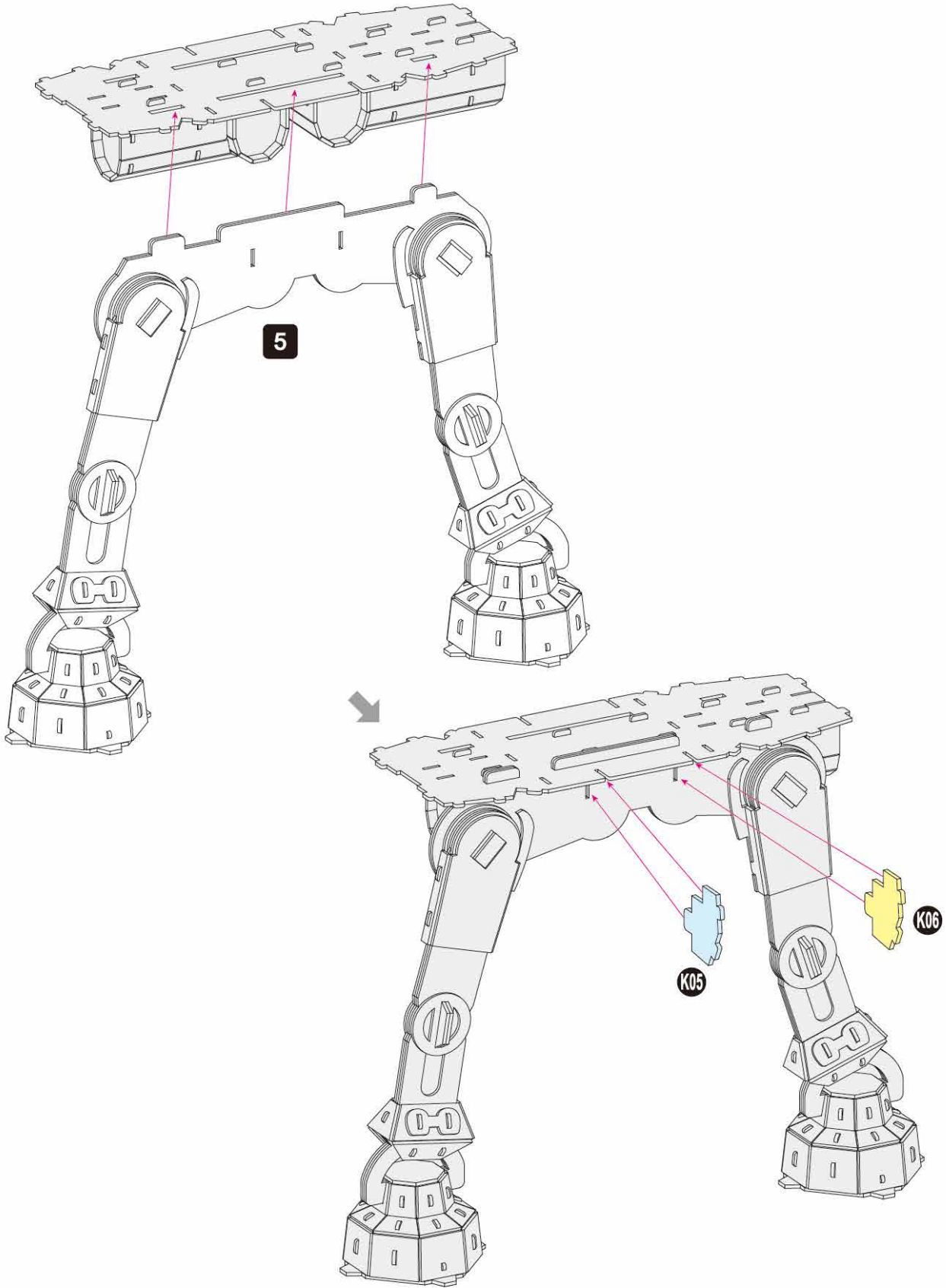

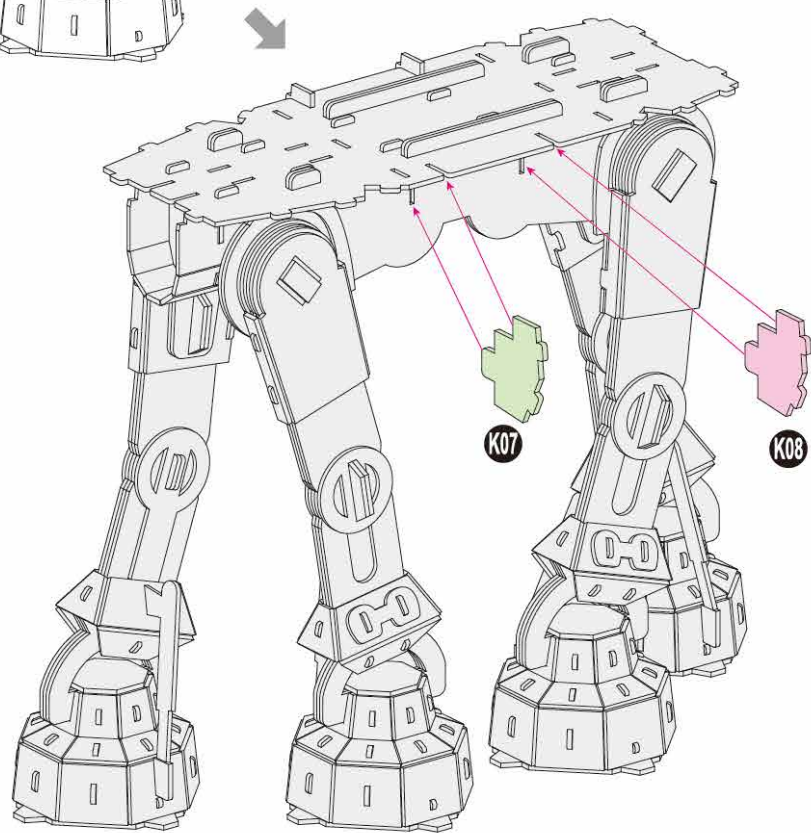
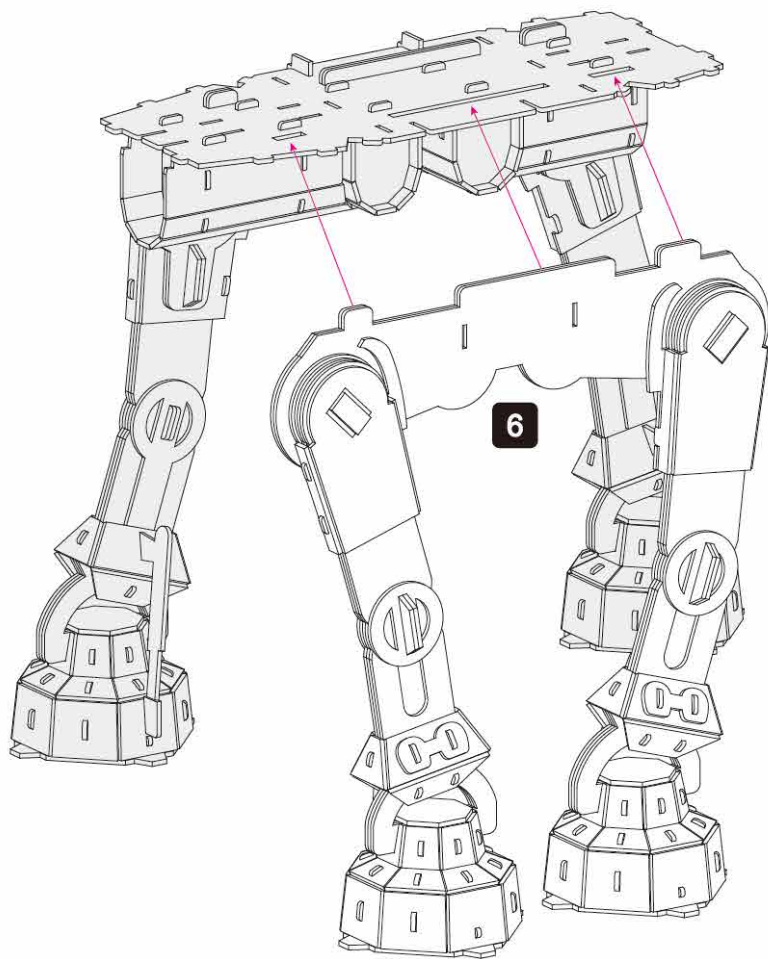



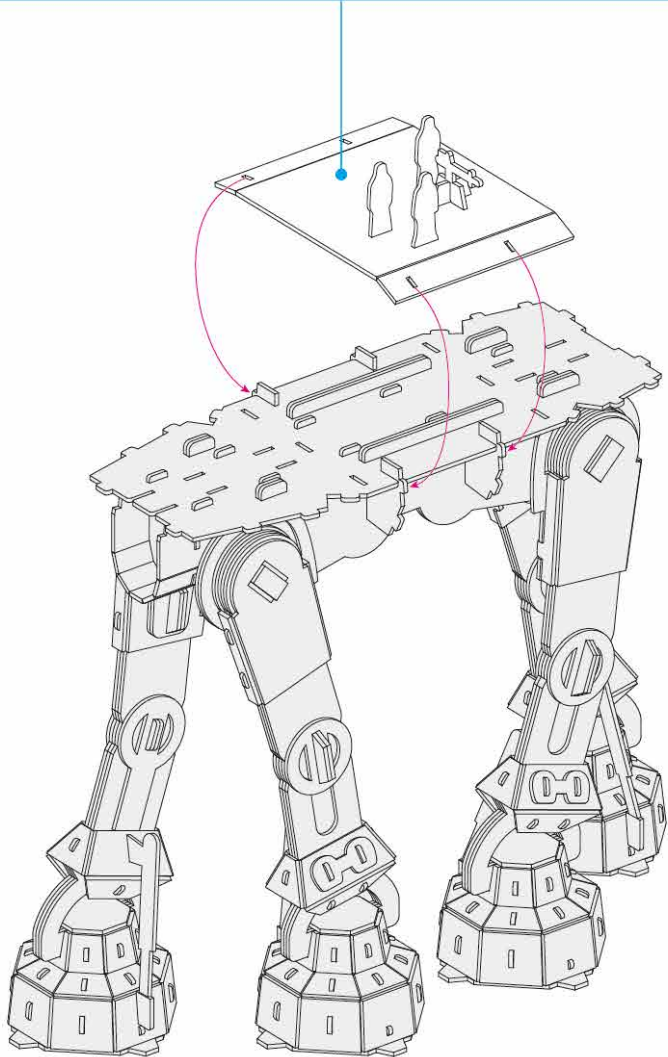
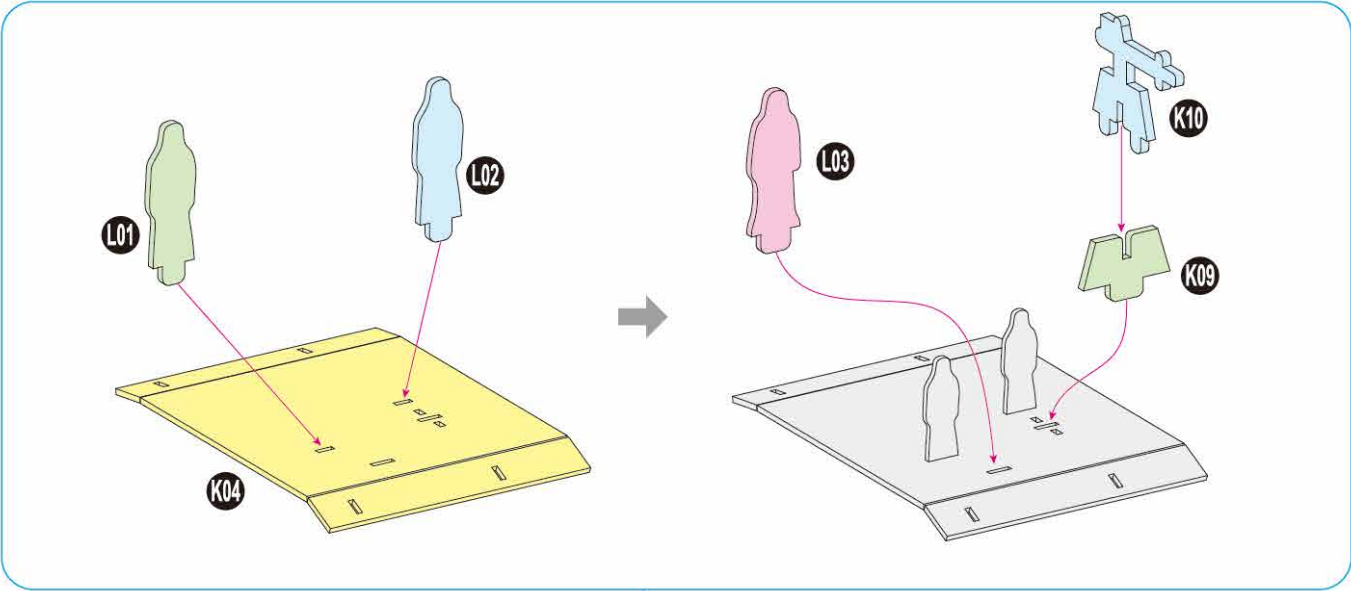

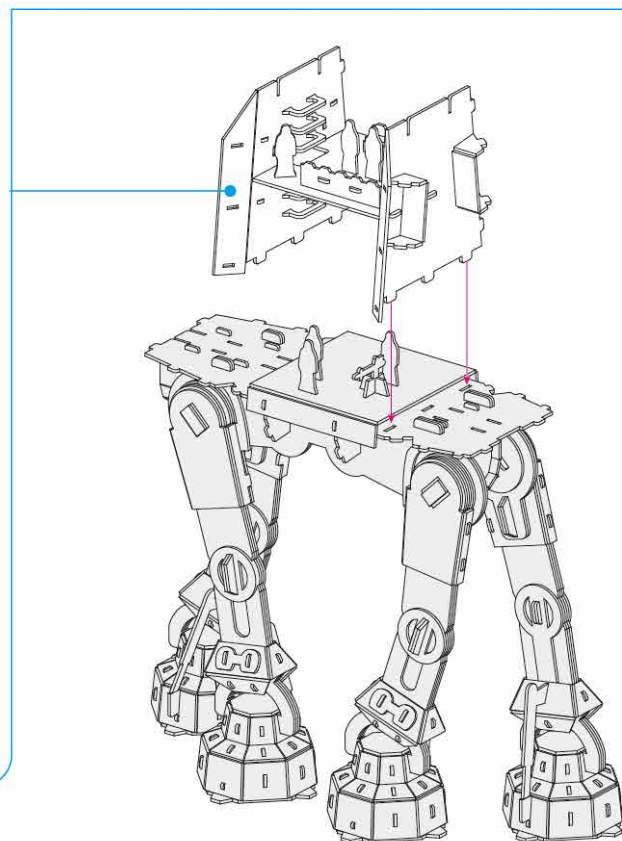
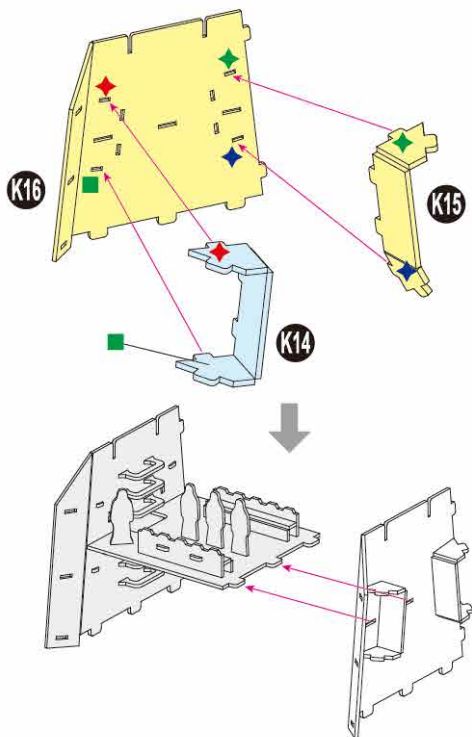
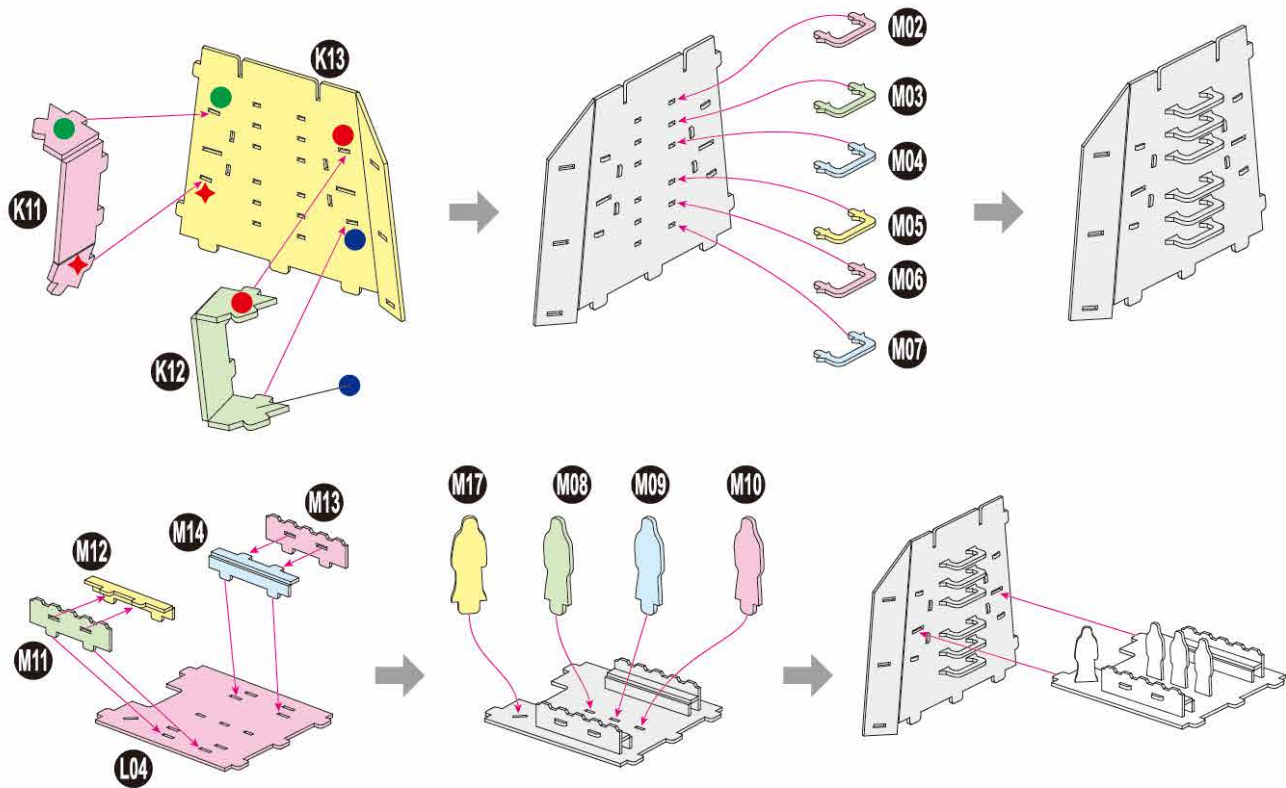

There are no more pieces left on Sheet K.

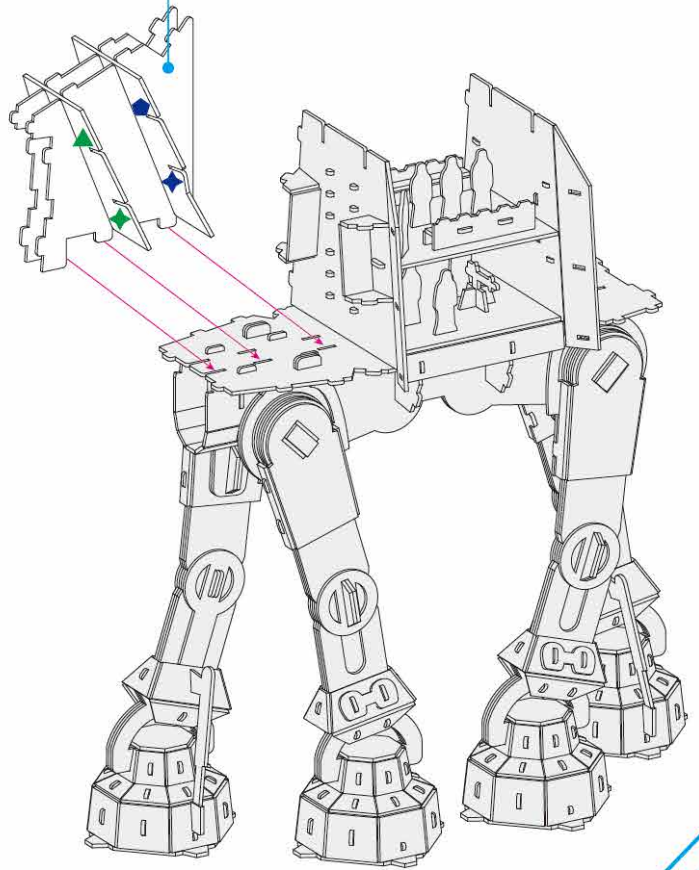
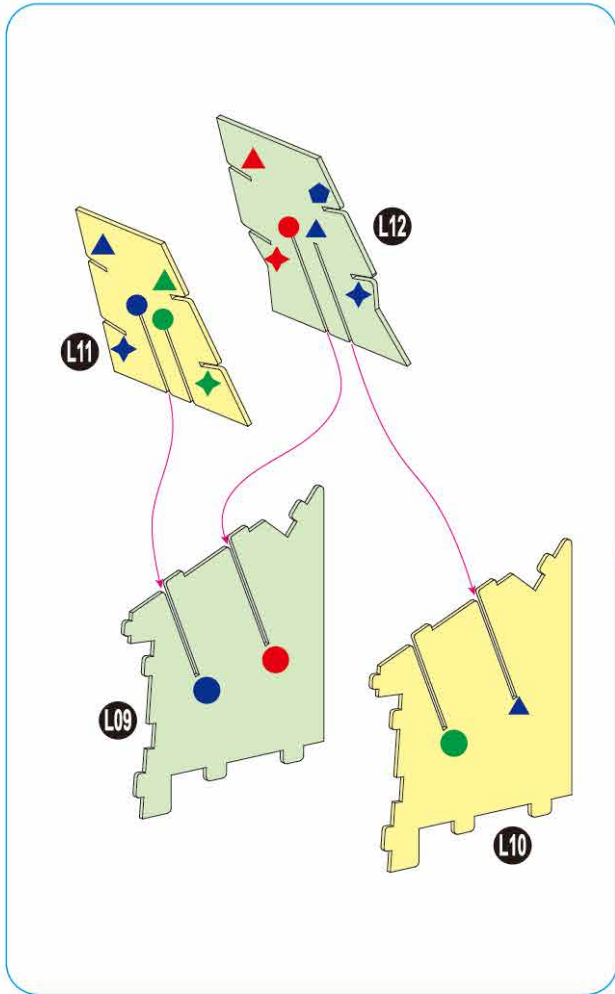



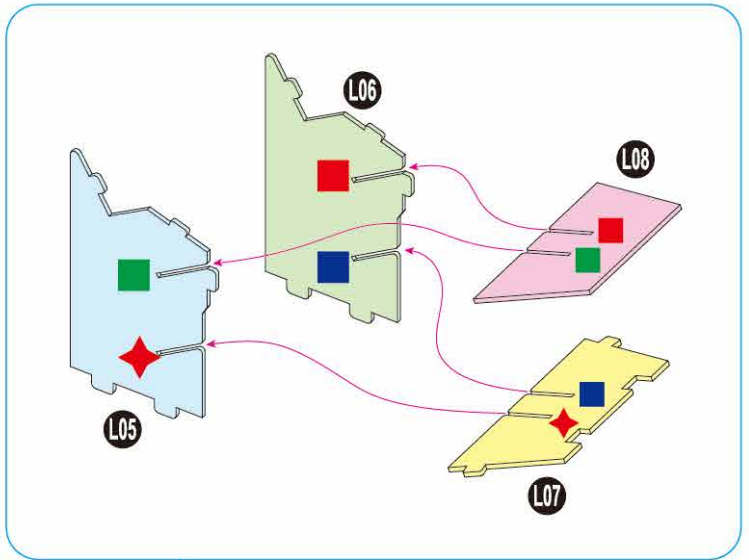
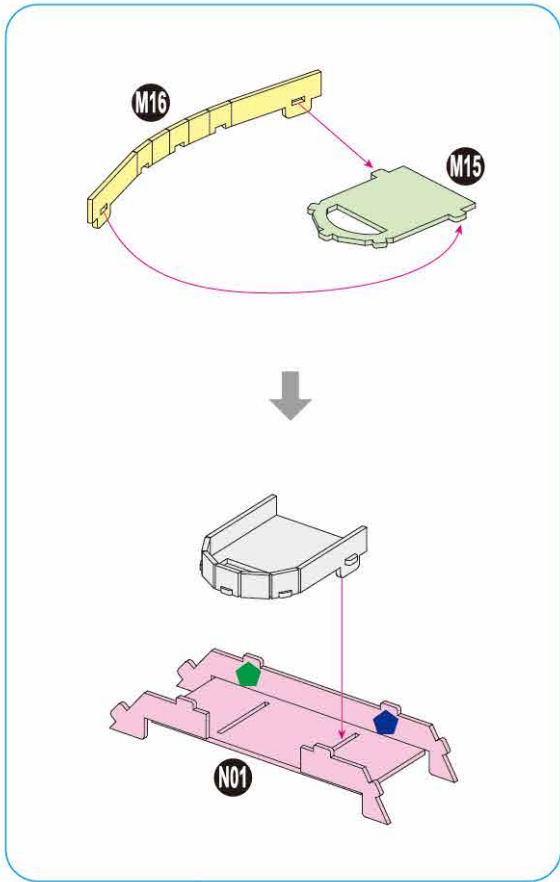

There are no more pieces left on Sheet L.

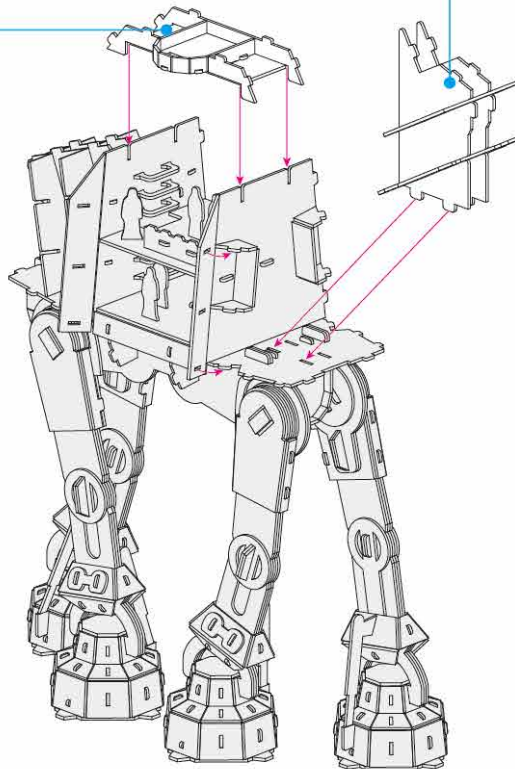

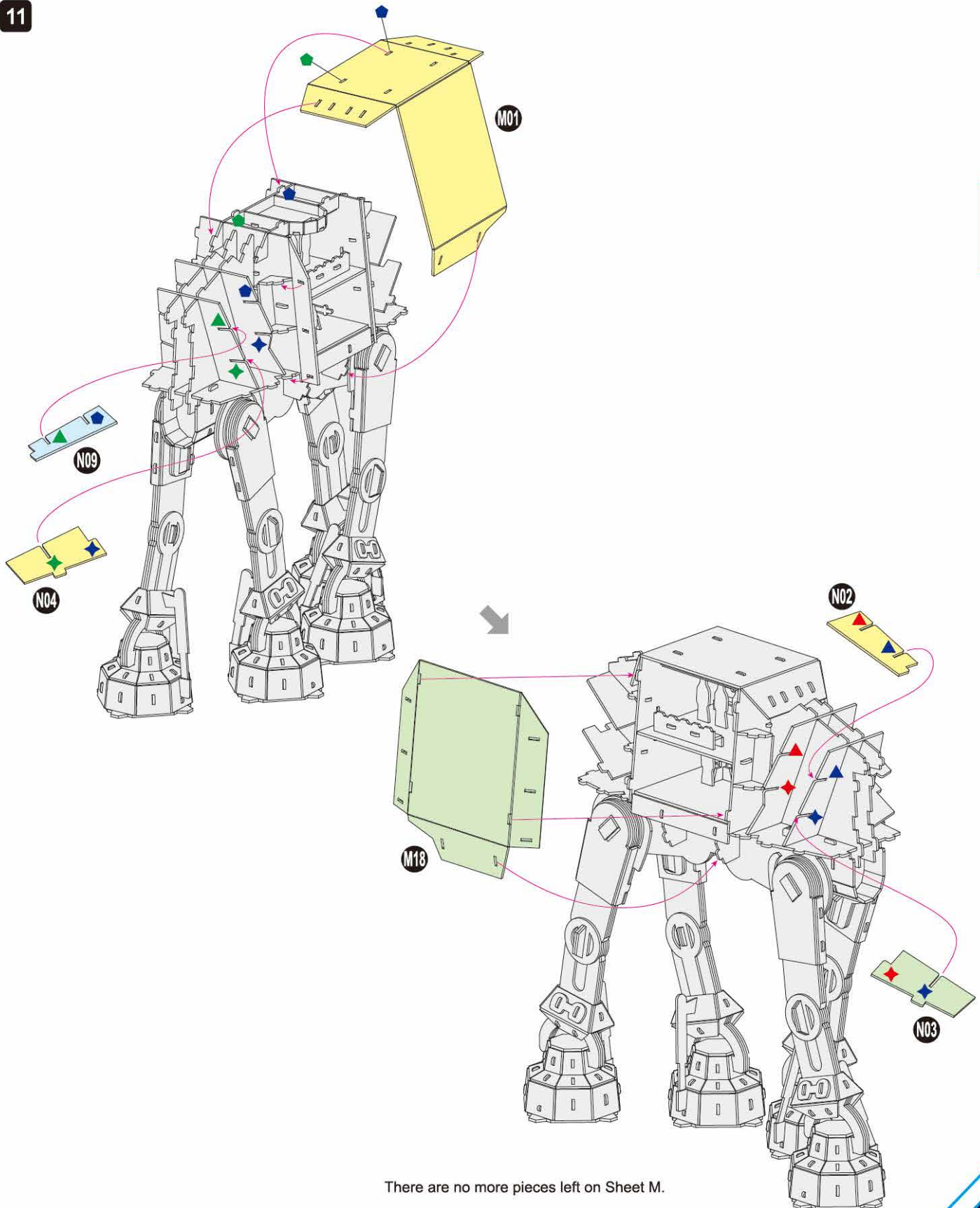

There are no more pieces left on Sheet M.

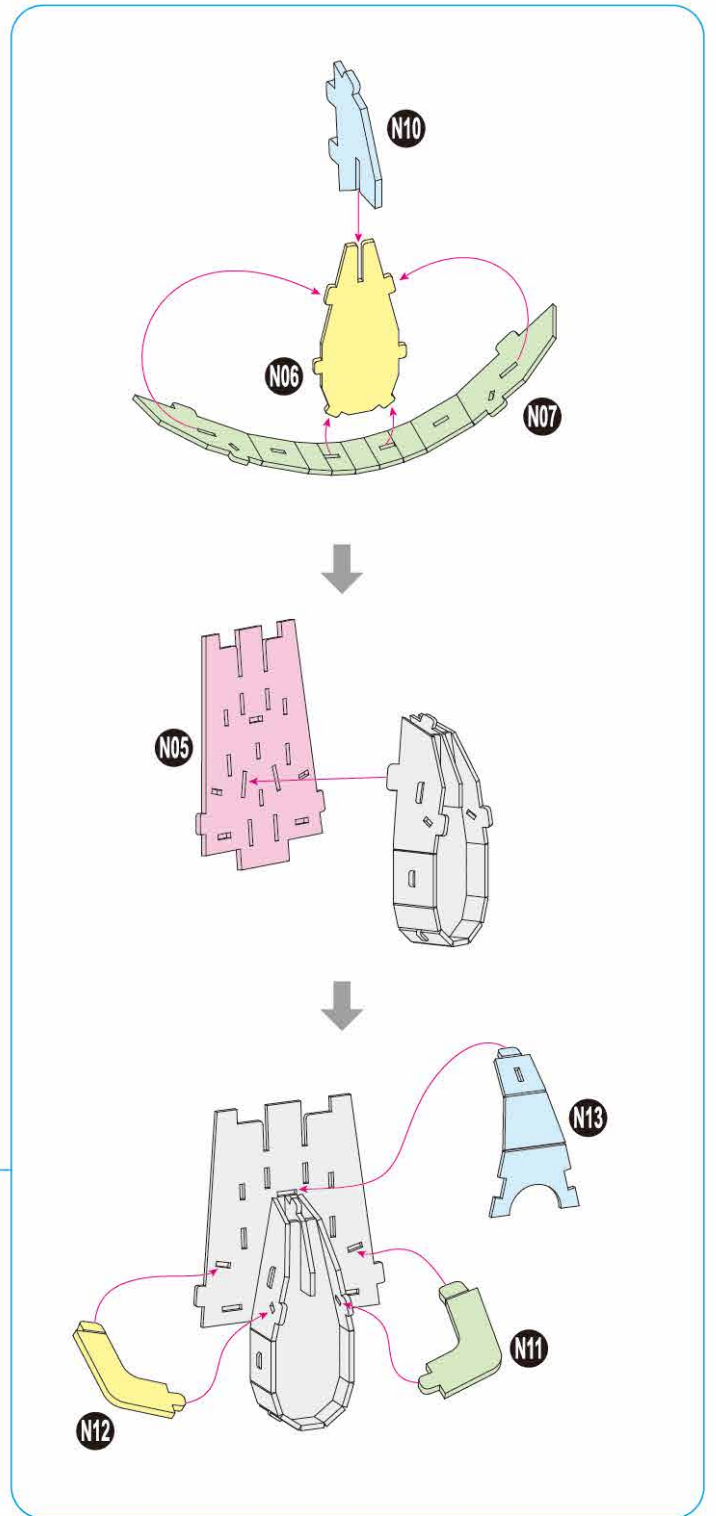
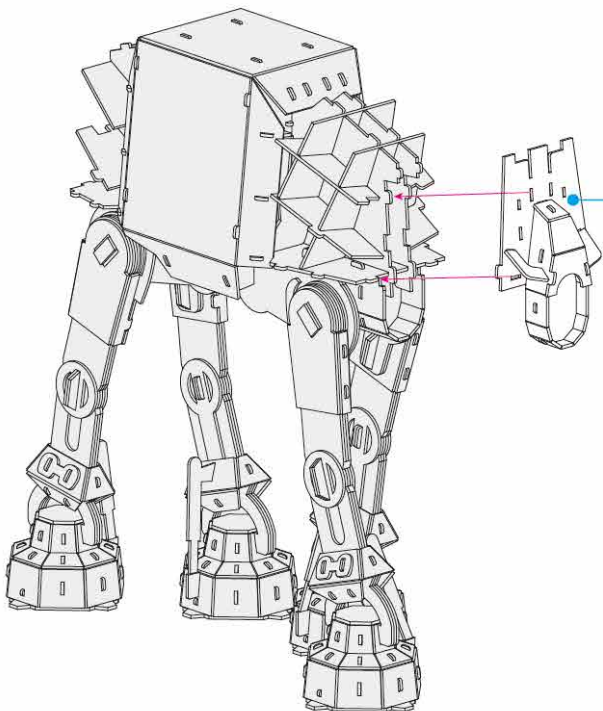



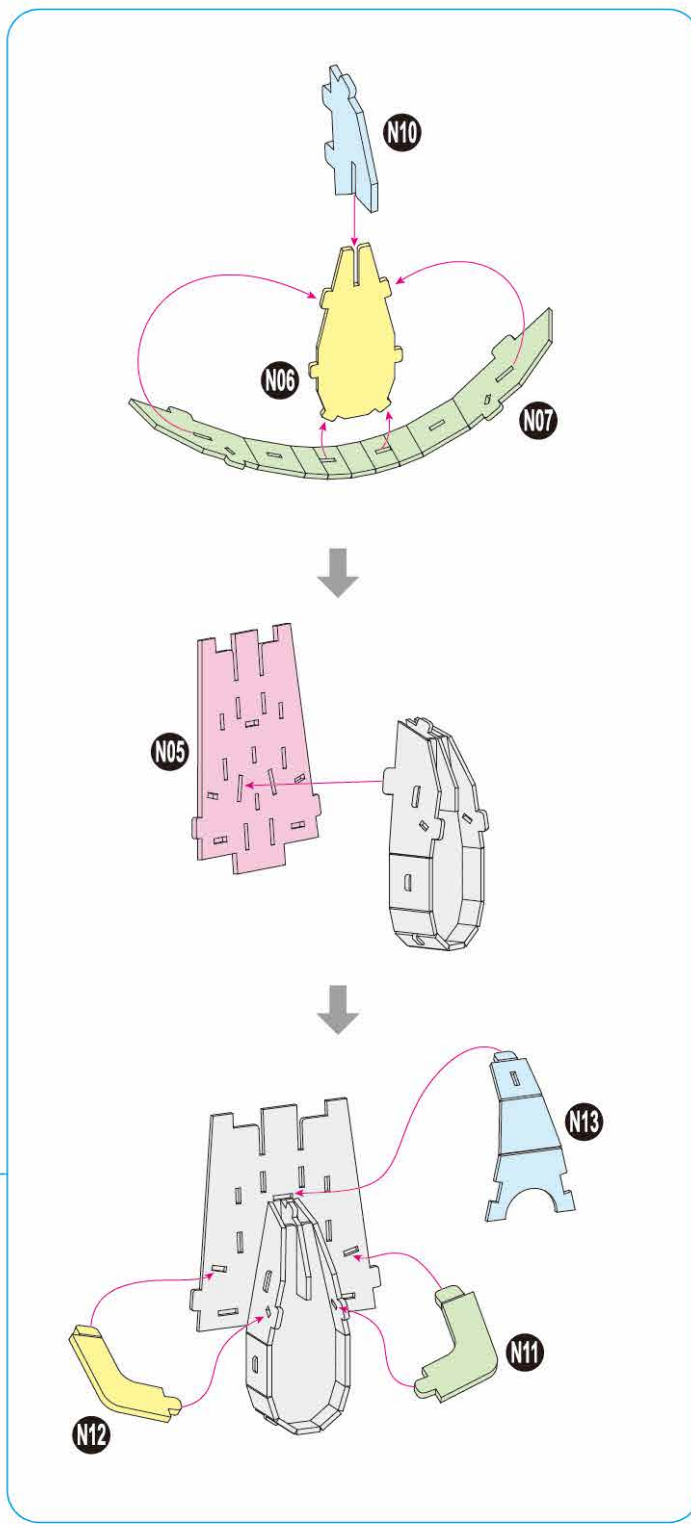
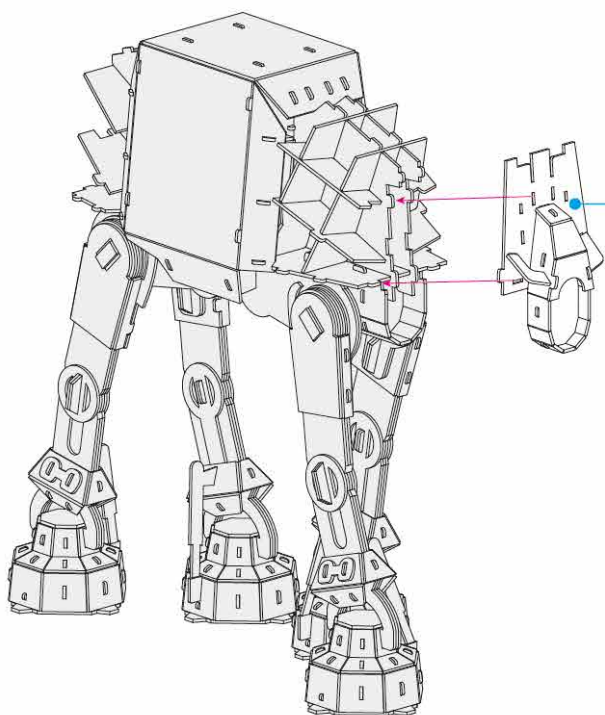

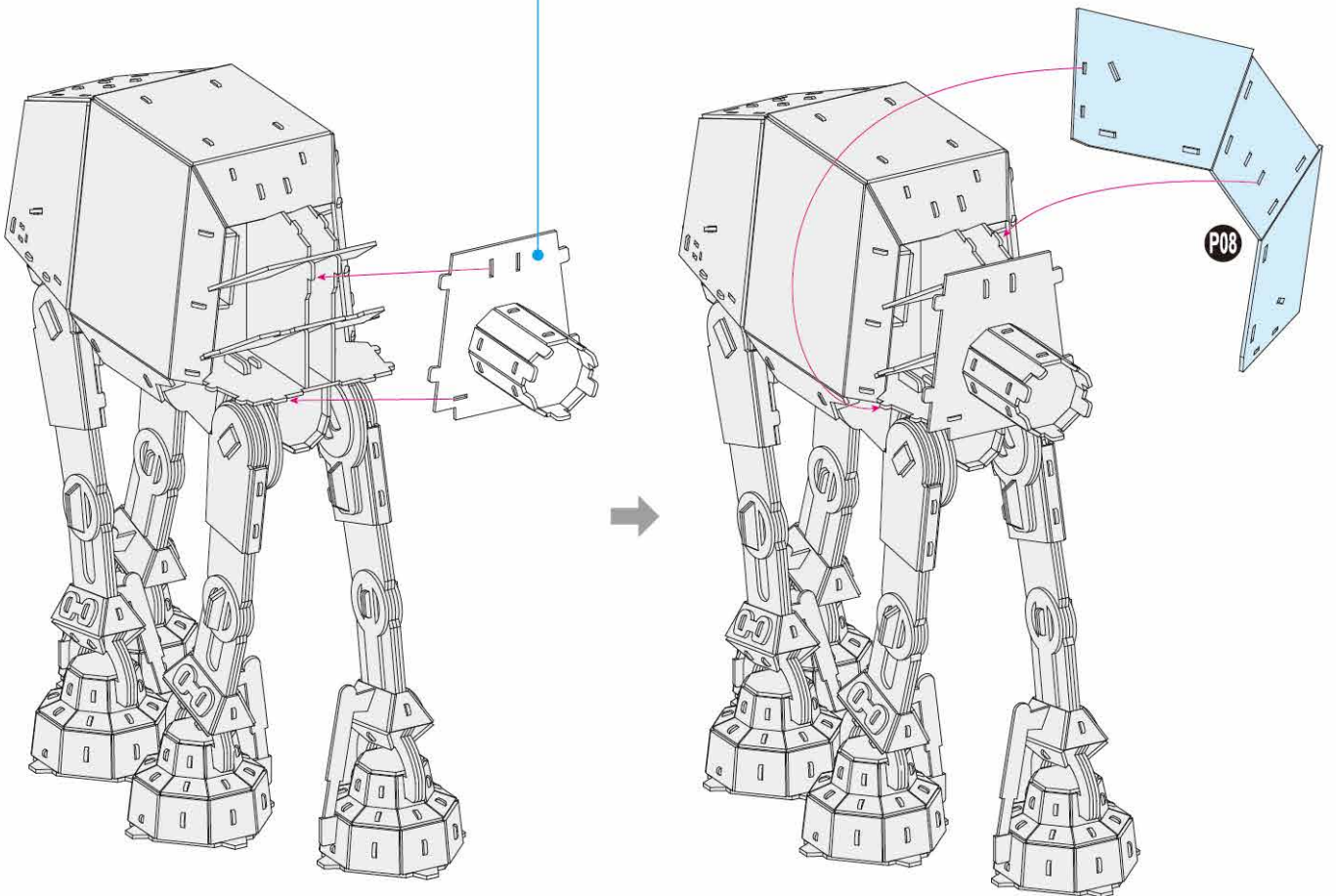
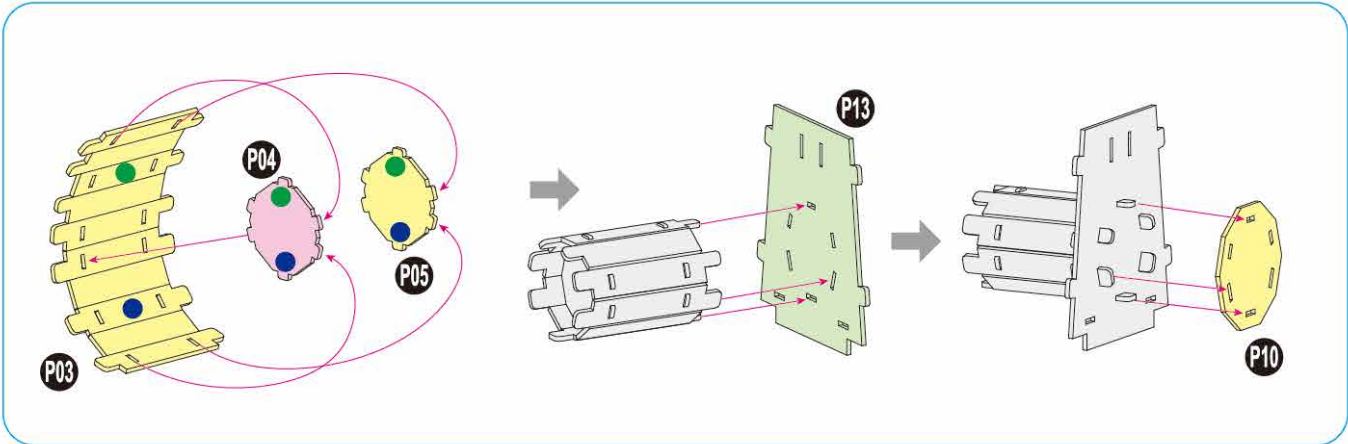

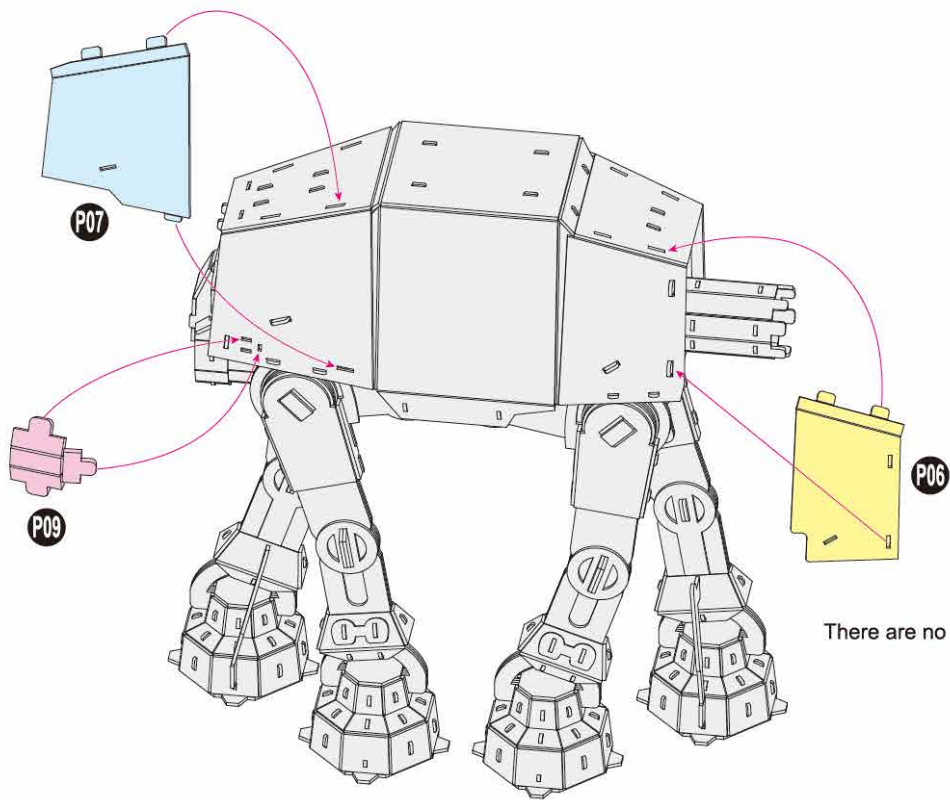

There are no more pieces left on Sheet P.

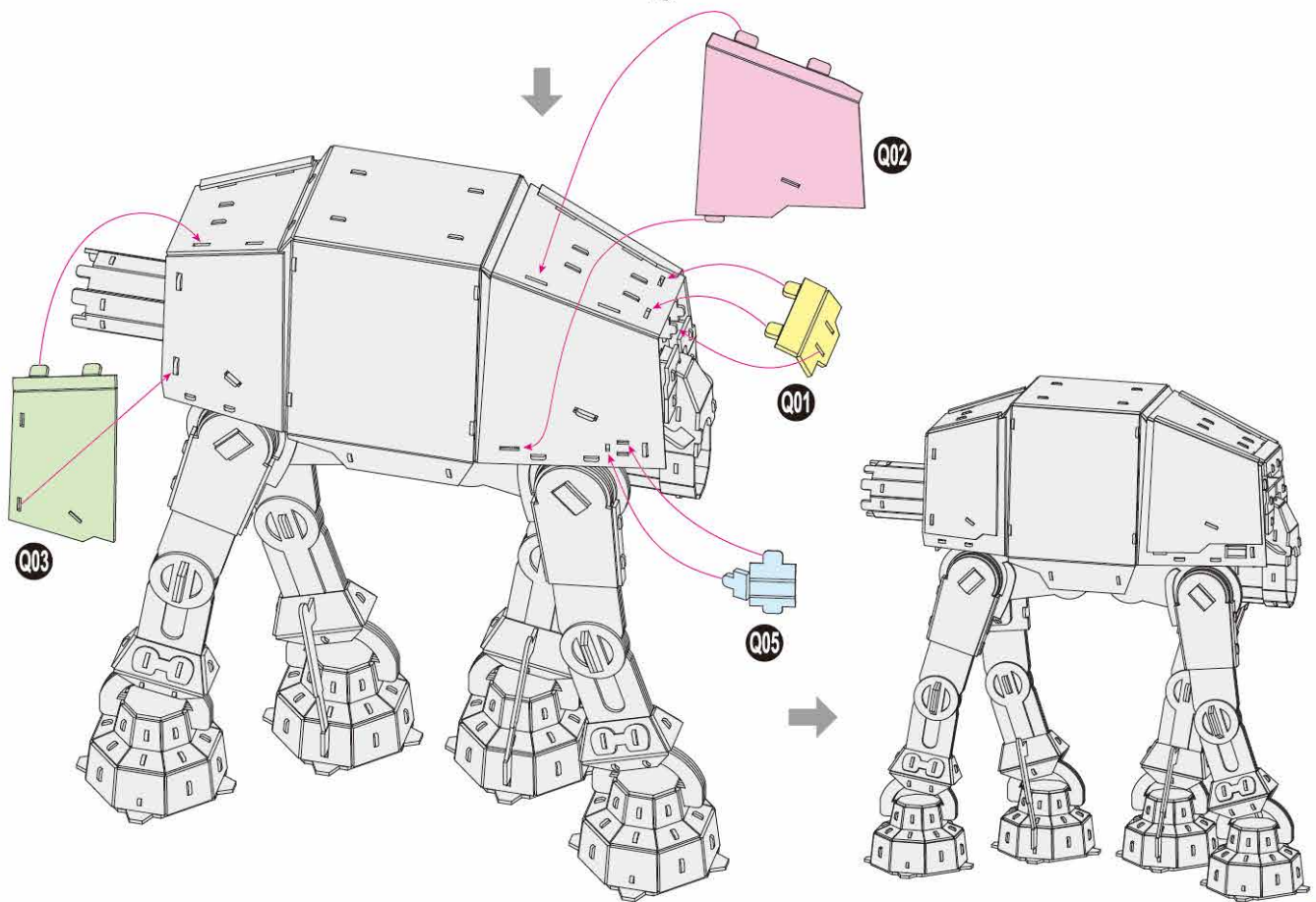



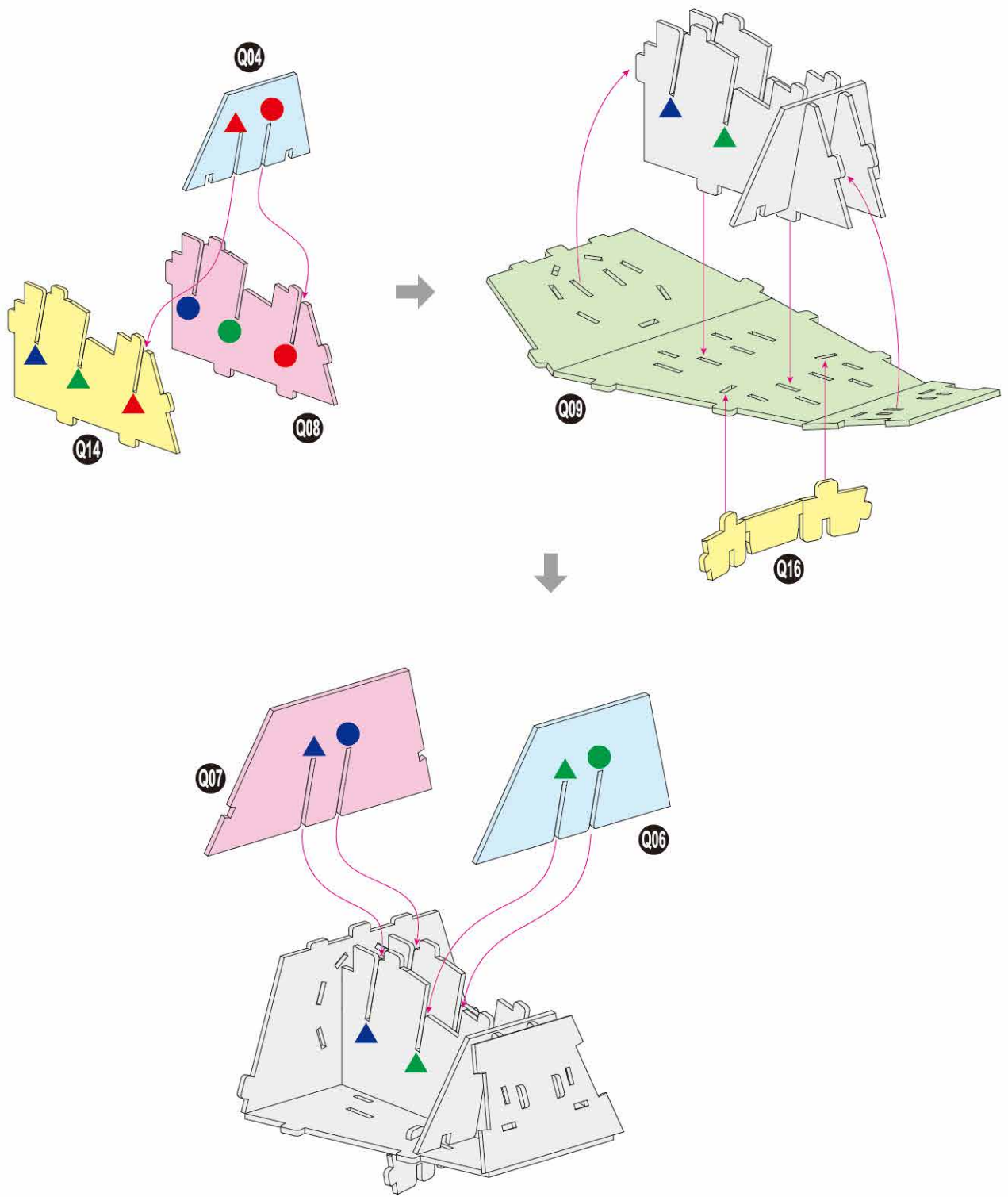

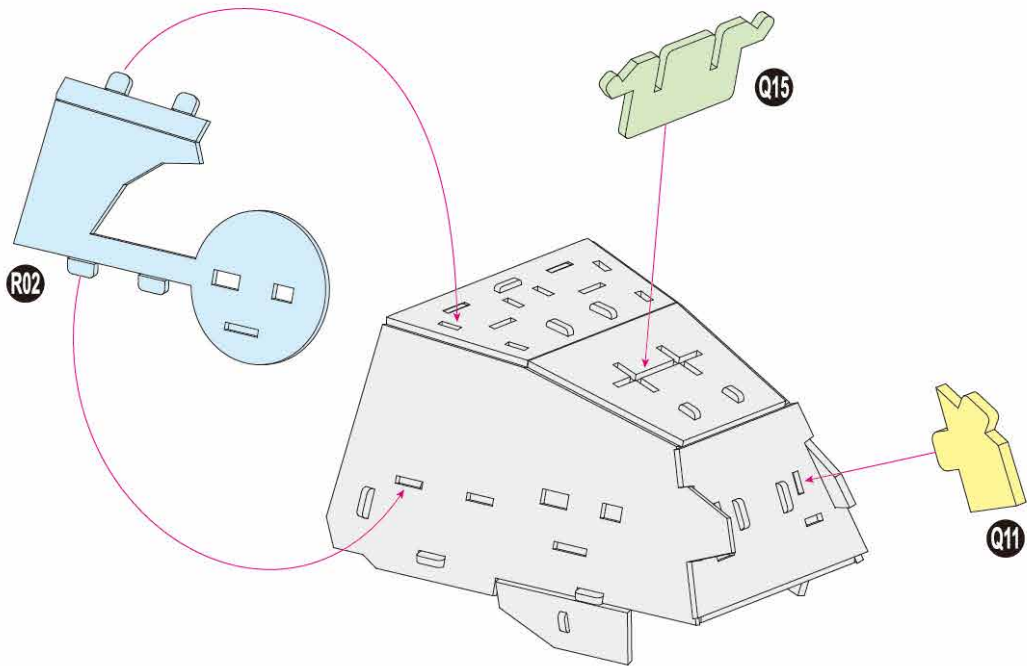
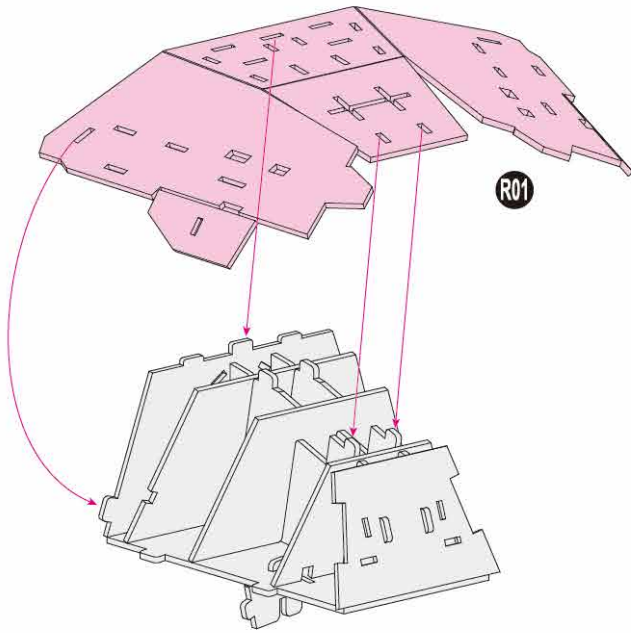

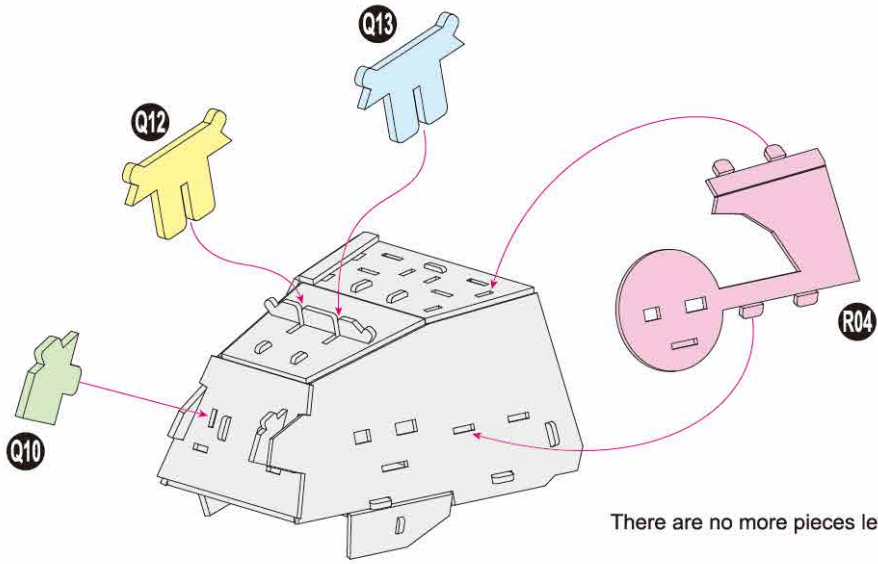

There are no more pieces left on Sheet Q.

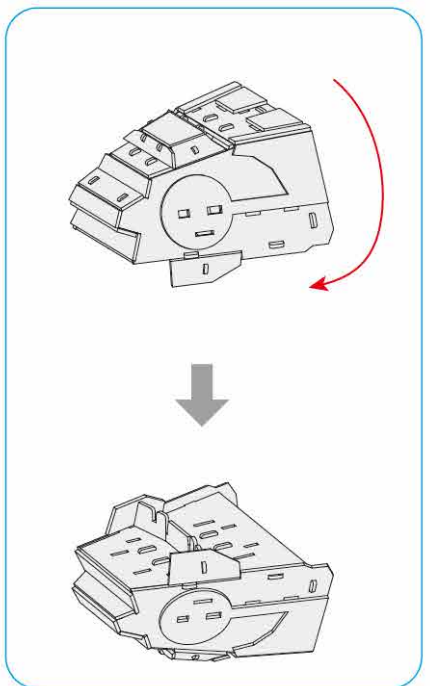
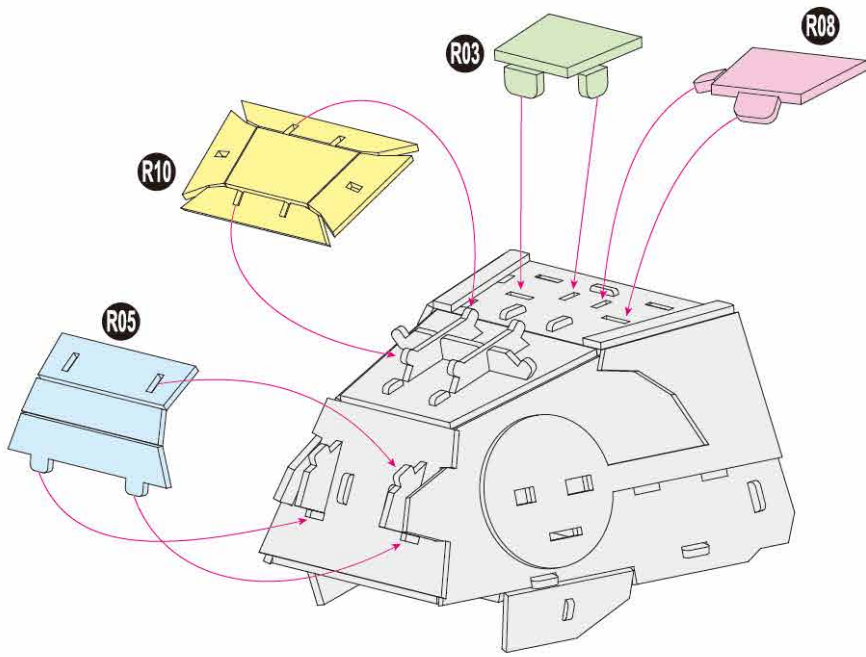



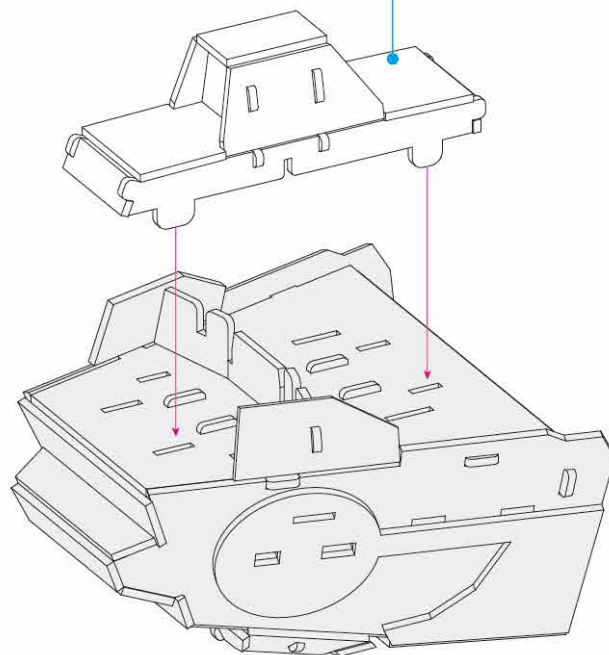
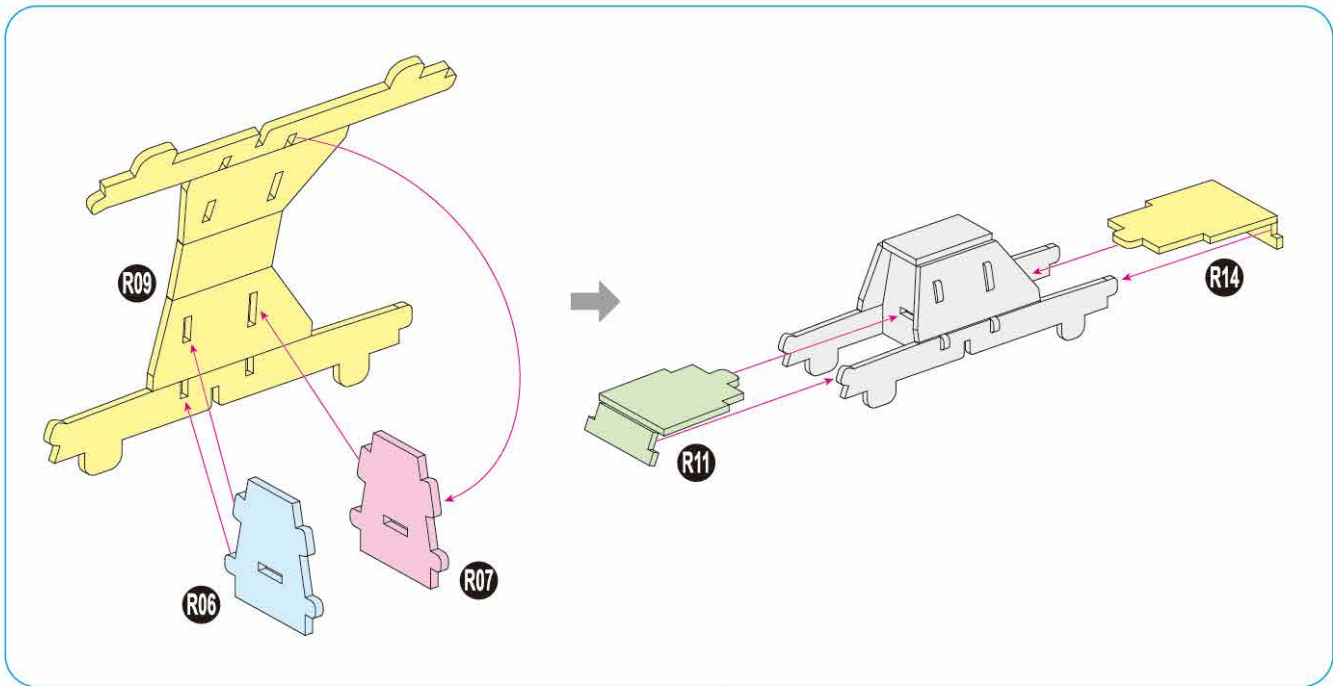

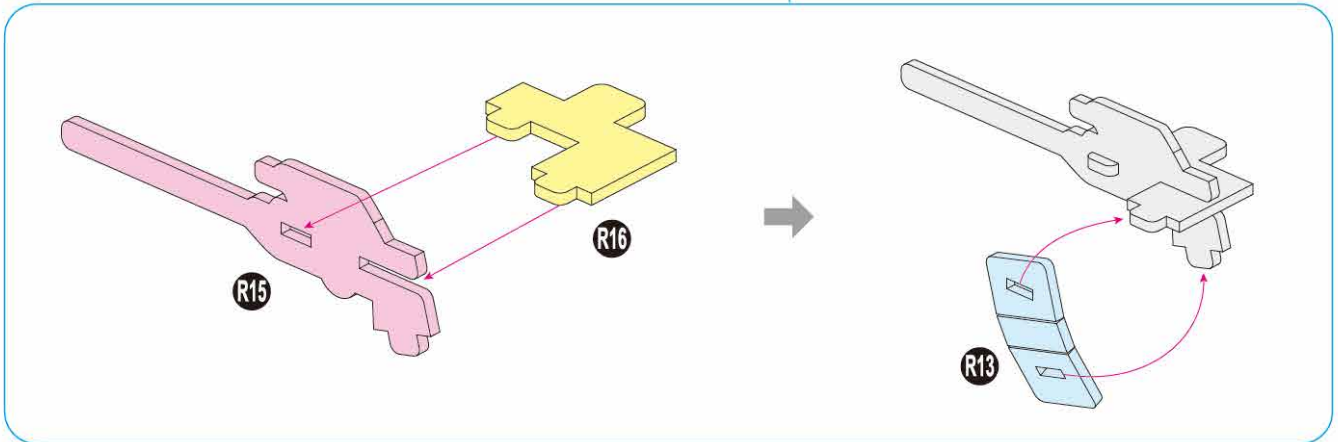
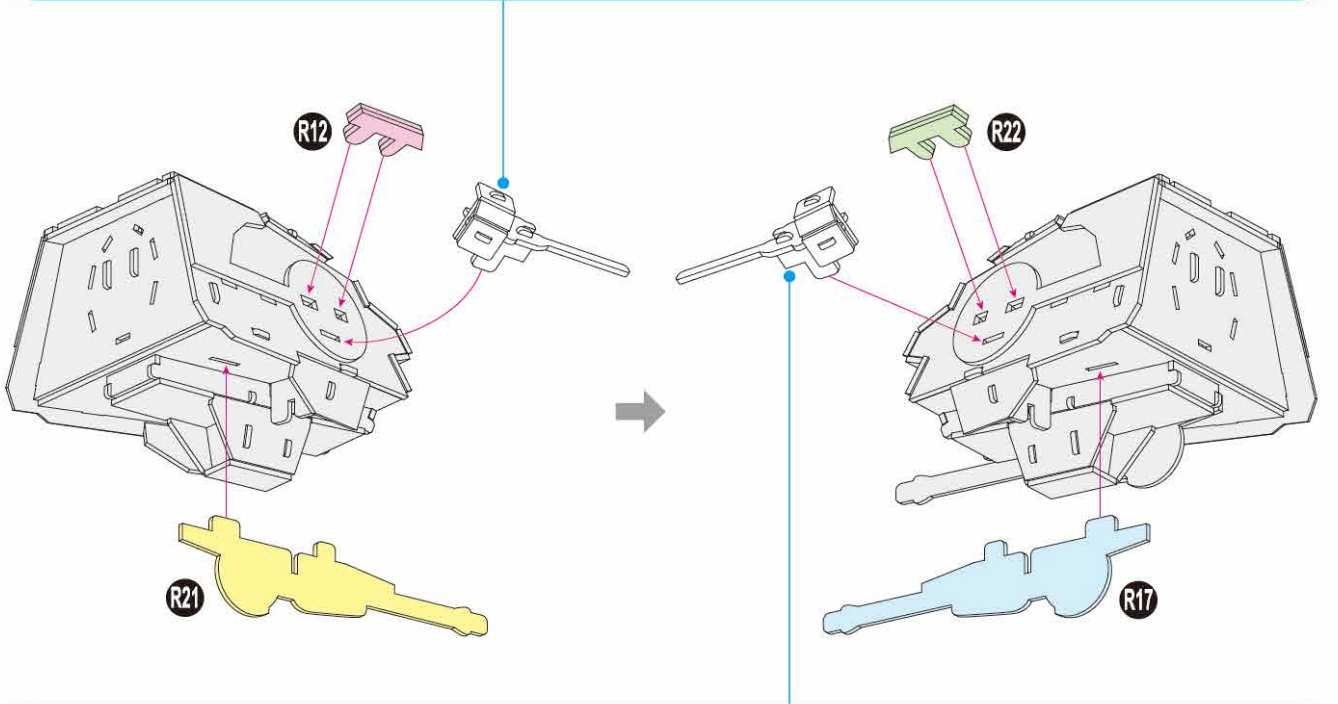
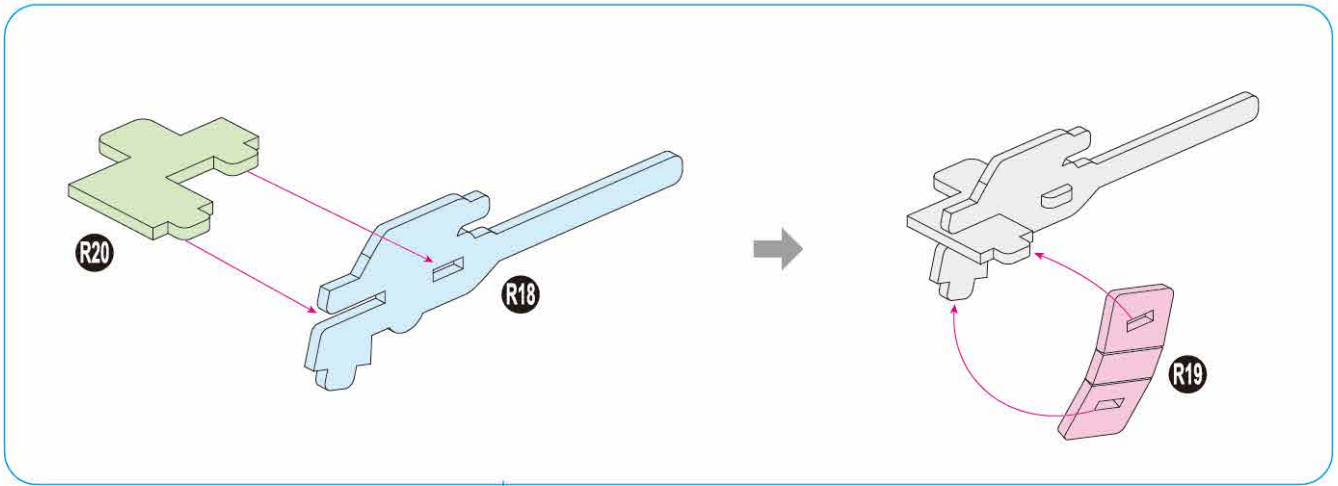

There are no more pieces left on Sheet R.

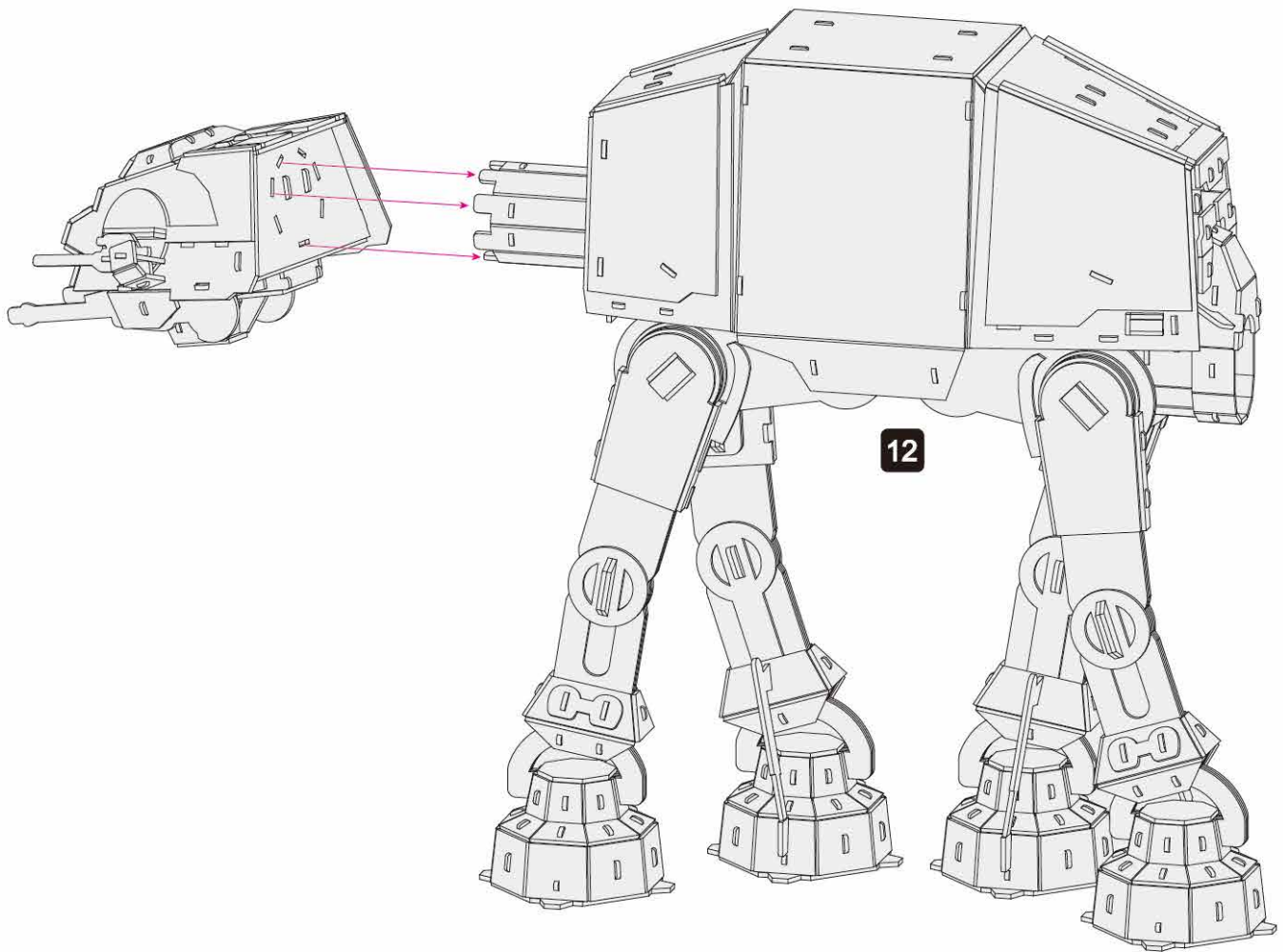



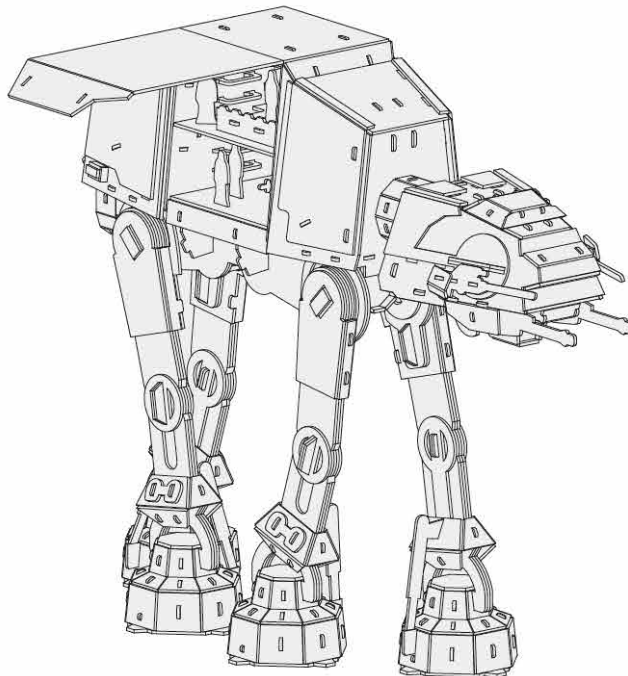
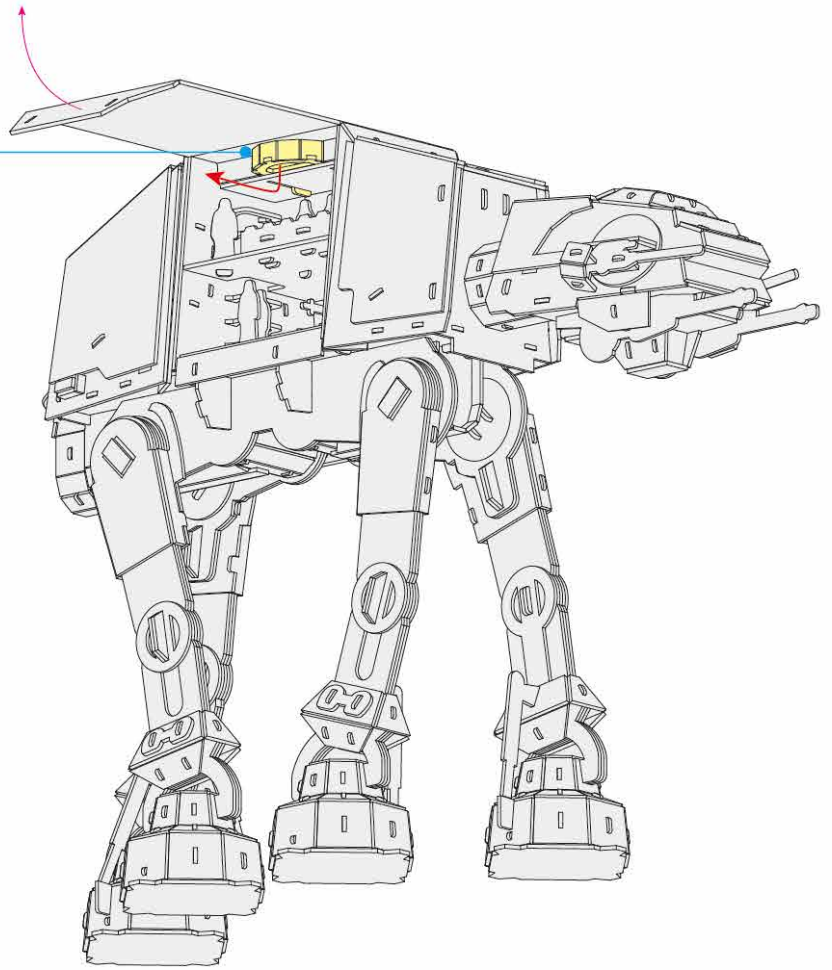
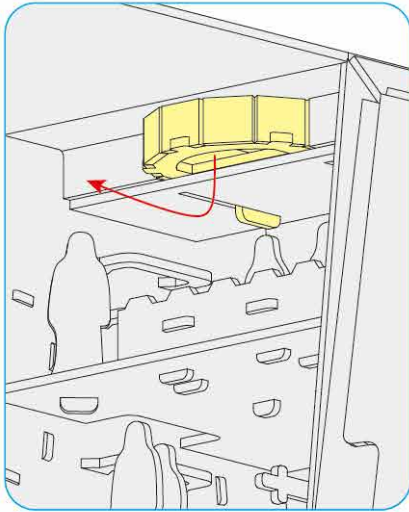

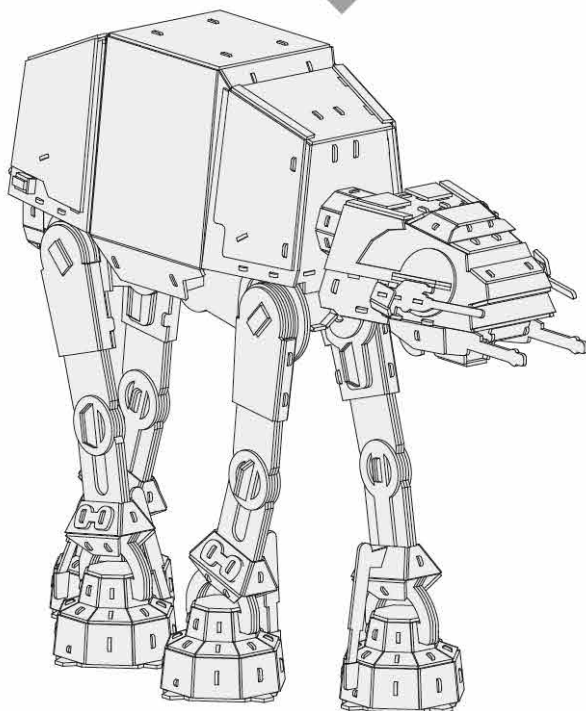
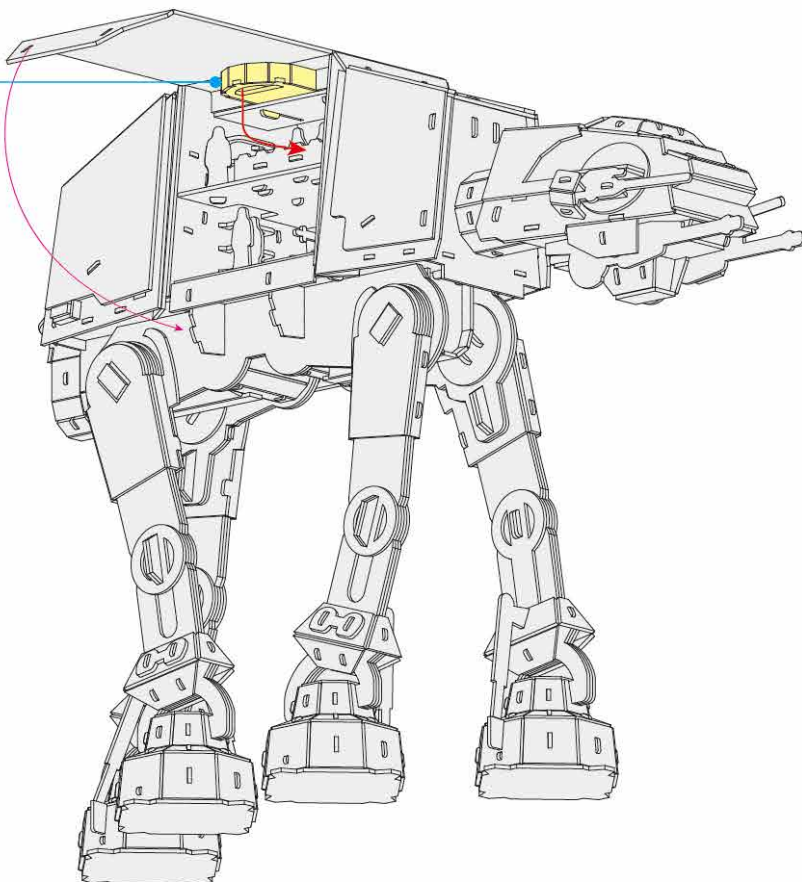
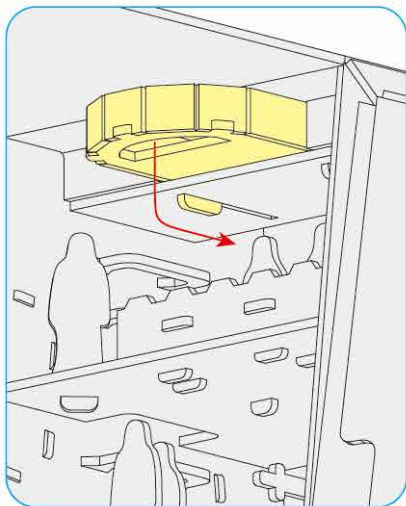



www.starwars.com  
© & ™ Lucasfilm Ltd.



TM & © 2024 SPIN MASTER LTD. ALL RIGHTS RESERVED. SPIN MASTER LTD., 225 KING STREET WEST, TORONTO ON M5V 3M2  
CANADA • SPIN MASTER INC., PMB #10053, 300 INTERNATIONAL DRIVE, SUITE 100, WILLIAMSVILLE, NY 14221 • SPIN MASTER  
INTERNATIONAL B.V., KINGSFORDWEG 151, 1043 GR AMSTERDAM, NL • SPIN MASTER AUSTRALIA PTY LTD, LEVEL 9, 205  
PACIFIC HWY, ST LEONARDS, NSW 2065 • SPIN MASTER TOYS UK LTD, BOSTON HOUSE, BOSTON DRIVE, BOURNE END,  
BUCKINGHAMSHIRE, SL8 5YS, UK • WWW.SPINMASTERGAMES.COM



MADE IN CHINA

T29954\_0007\_20148364\_GEN\_IS\_R2